

通过旋转独特的锁定结构型法兰盘即可改变选择位。且，法兰盘具备每旋转45°即可固定的锁定功能，所以法兰盘无旋转偏移，面板安装容易。

选择角的位置变更方法

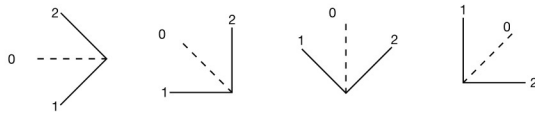





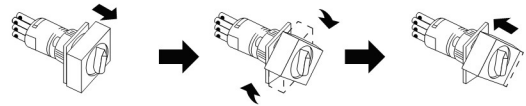















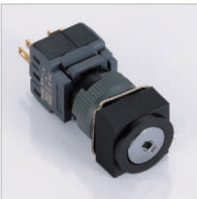















【3位选择形状例】



出厂时的选择位位置



首先将法兰盘用力拉出解除锁定，即可旋转法兰盘。选择角的位置在任意45°的位置上按下即可进行锁定。

名称/外观 Product appearance	操作位规格 Operation	触点 Contact	产品型号 Model		
圆形 / Round  	90° 2位 2 Postion	 自锁/Maintained	F16-6112		
		 自复/Momentary	F16-6110		
		 自锁/Maintained	F16-6122		
		 自复/Momentary	F16-6120		
		90° 3位 3 Postion	 自锁/Maintained	F16-7123	
			 左锁右复/Left lock Right reset	F16-7127	
	 左复右锁/Left reset Right lock		F16-7126		
	 自复/Momentary		F16-7121		
	 自锁/Maintained		F16-7133		
	 左锁右复/Left lock Right reset		F16-7137		
	方形 / Square  	90° 2位 2 Postion	 自锁/Maintained	F16-6212	
			 自复/Momentary	F16-6210	
			 自锁/Maintained	F16-6222	
			 自复/Momentary	F16-6220	
			90° 3位 3 Postion	 自锁/Maintained	F16-7223
				 左锁右复/Left lock Right reset	F16-7227
		 左复右锁/Left reset Right lock		F16-7226	
		 自复/Momentary		F16-7221	
 自锁/Maintained		F16-7233			
 左锁右复/Left lock Right reset		F16-7237			
长方形 / Rectangle  		90° 2位 2 Postion	 自锁/Maintained	F16-6312	
			 自复/Momentary	F16-6310	
	 自锁/Maintained		F16-6322		
	 自复/Momentary		F16-6320		
	90° 3位 3 Postion		 自锁/Maintained	F16-7323	
			 左锁右复/Left lock Right reset	F16-7327	
		 左复右锁/Left reset Right lock	F16-7326		
		 自复/Momentary	F16-7321		
		 自锁/Maintained	F16-7333		
		 左锁右复/Left lock Right reset	F16-7337		
	 左复右锁/Left reset Right lock	F16-7336			
	 自复/Momentary	F16-7331			

选择钮, 钥匙钮手柄位置/Selector and Key Switch Handle Position

操作位规格 Operation		触点 Contact	
		↙	↑
90° 2位 2 Position	<p>自锁 Maintained</p>	<p>自复 Momentary</p>	<p>单刀 SPDT</p>
			<p>双刀 DPDT</p>
90° 3位 3 Position	<p>自锁 Maintained</p>	<p>左锁右复 Left lock Right reset</p>	<p>三刀 TPDT</p>
	<p>左复右锁 Left reset Right lock</p>	<p>自复 Momentary</p>	

圆形钥匙钮

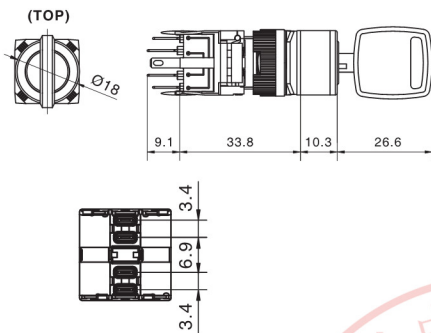

方形钥匙钮

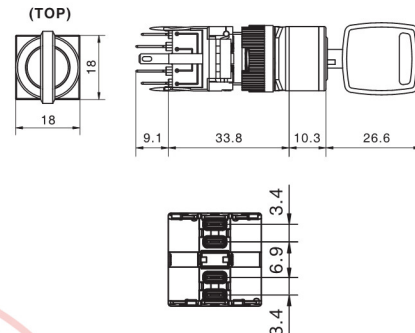
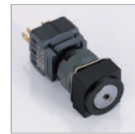

长方形钥匙钮

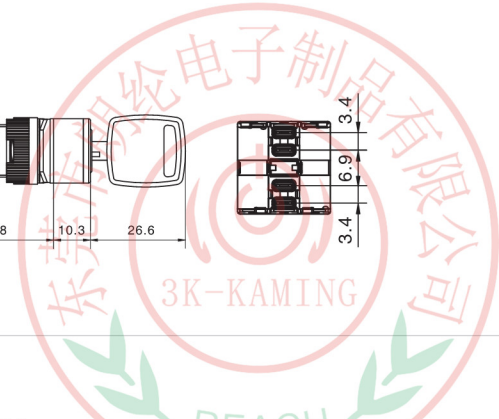
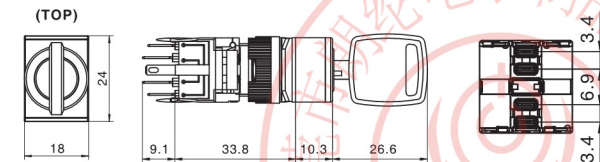

□ 安装尺寸图 / Installation size

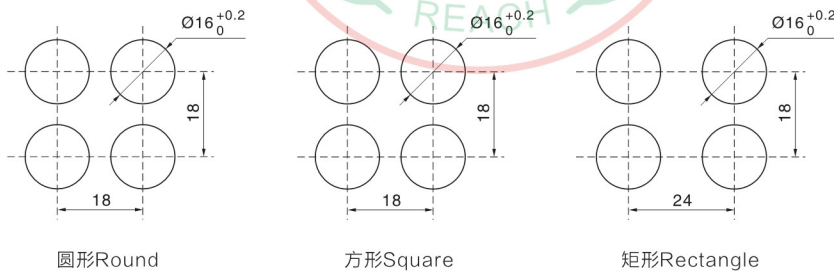

□ 端子排列图/ Terminal style

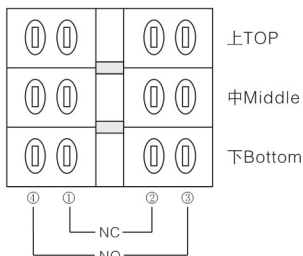

- 右侧产品的底座看成正面时, 端子排列顺序及内部电路图。
As shown at right, the base of product to be seen as front side, which show terminal disposition and inside coil drawing.
- 产品出产时基本安装触点座1C(1a+1b), 在需要时请指定增加最多3C(1a+1b)。
Product assemble contact 1C(1a+1b), if needed, Please appoint to add at least 3C(1a+1b)