

通过旋转独特的锁定结构型法兰盘即可改变选择位。且，法兰盘具备每旋转45°即可固定的锁定功能，所以法兰盘无旋转偏移，面板安装容易。

选择角的位置变更方法

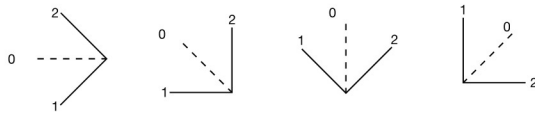





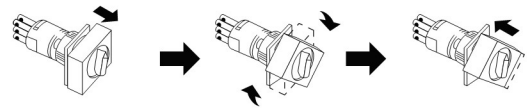















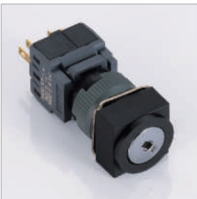













【3位选择形状例】





















出厂时的选择位位置



首先将法兰盘用力拉出解除锁定，即可旋转法兰盘。选择角的位置在任意45°的位置上按下即可进行锁定。

名称/外观 Product appearance	操作位规格 Operation	触点 Contact	产品型号 Model		
圆形 / Round  	90° 2位 2 Postion	 自锁/Maintained	单刀/SPDT <b>F16-6112</b>		
		 自复/Momentary	单刀/SPDT <b>F16-6110</b>		
		 自锁/Maintained	双刀/DPDT <b>F16-6122</b>		
		 自复/Momentary	双刀/DPDT <b>F16-6120</b>		
		90° 3位 3 Postion	 自锁/Maintained	双刀/DPDT <b>F16-7123</b>	
			 左锁右复/Left lock Right reset	双刀/DPDT <b>F16-7127</b>	
	 左复右锁/Left reset Right lock		双刀/DPDT <b>F16-7126</b>		
	 自复/Momentary		双刀/DPDT <b>F16-7121</b>		
	 自锁/Maintained		三刀/TPDT <b>F16-7133</b>		
	 左锁右复/Left lock Right reset		三刀/TPDT <b>F16-7137</b>		
	方形 / Square  	90° 2位 2 Postion	 自锁/Maintained	单刀/SPDT <b>F16-6212</b>	
			 自复/Momentary	单刀/SPDT <b>F16-6210</b>	
			 自锁/Maintained	双刀/DPDT <b>F16-6222</b>	
			 自复/Momentary	双刀/DPDT <b>F16-6220</b>	
			90° 3位 3 Postion	 自锁/Maintained	双刀/DPDT <b>F16-7223</b>
				 左锁右复/Left lock Right reset	双刀/DPDT <b>F16-7227</b>
		 左复右锁/Left reset Right lock		双刀/DPDT <b>F16-7226</b>	
		 自复/Momentary		双刀/DPDT <b>F16-7221</b>	
 自锁/Maintained		三刀/TPDT <b>F16-7233</b>			
 左锁右复/Left lock Right reset		三刀/TPDT <b>F16-7237</b>			
长方形 / Rectangle  		90° 2位 2 Postion	 自锁/Maintained	单刀/SPDT <b>F16-6312</b>	
			 自复/Momentary	单刀/SPDT <b>F16-6310</b>	
	 自锁/Maintained		双刀/DPDT <b>F16-6322</b>		
	 自复/Momentary		双刀/DPDT <b>F16-6320</b>		
	90° 3位 3 Postion		 自锁/Maintained	双刀/DPDT <b>F16-7323</b>	
			 左锁右复/Left lock Right reset	双刀/DPDT <b>F16-7327</b>	
		 左复右锁/Left reset Right lock	双刀/DPDT <b>F16-7326</b>		
		 自复/Momentary	双刀/DPDT <b>F16-7321</b>		
		 自锁/Maintained	三刀/TPDT <b>F16-7333</b>		
		 左锁右复/Left lock Right reset	三刀/TPDT <b>F16-7337</b>		
	 左复右锁/Left reset Right lock	三刀/TPDT <b>F16-7336</b>			
	 自复/Momentary	三刀/TPDT <b>F16-7331</b>			

操作位规格 Operation				触点 Contact				
				↙	↑	↗		
90° 2位 2 Position	 自锁 Maintained		 自复 Momentary		单刀 SPDT			
					双刀 DPDT			
90° 3位 3 Position	 自锁 Maintained		 左锁右复 Left lock Right reset		 左复右锁 Left reset Right lock		 自复 Momentary	
					三刀 TPDT			
								
								

圆形钥匙钮

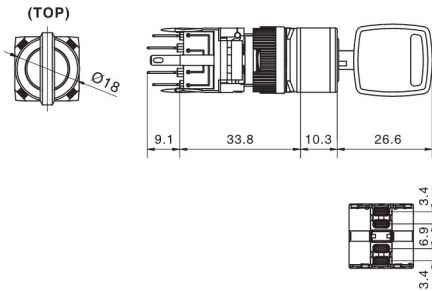

方形钥匙钮

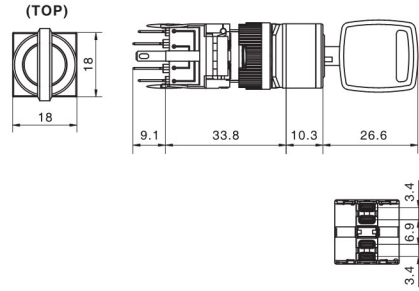
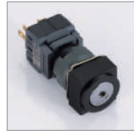

长方形钥匙钮

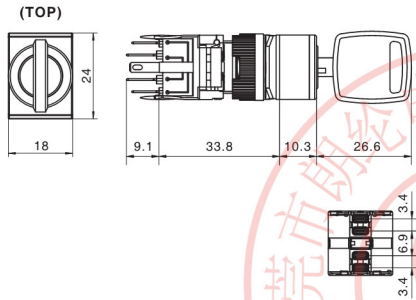

□ 安装尺寸图 / Installation size

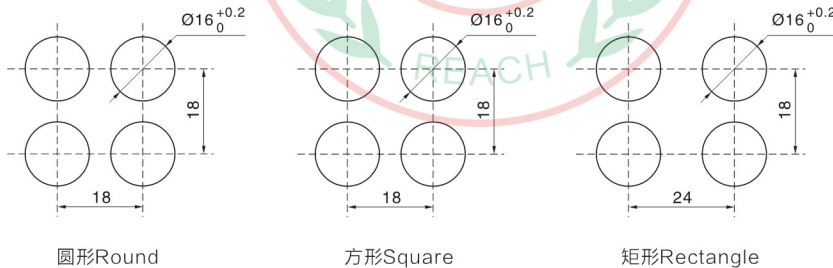

□ 端子排列图/ Terminal style

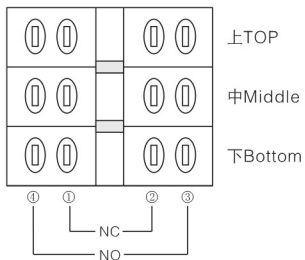

□ 右侧产品的底座看成正面时，端子排列顺序及内部电路图。  
As shown at right, the base of product to be seen as front side, which show terminal disposition and inside coil drawing.

□ 产品出产时基本安装触点座1C(1a+1b)，  
在需要时请指定增加最多3C(1a+1b)。  
Product assemble contact 1C(1a+1b)，  
if needed, Please appoint to add at least 3C(1a+1b)