

REV	LOCATIONS	DESCRIPTION	DATE	REVISER	APPD



Electrical

Current Rating: 1A AC(rms)/DC
Voltage Rating: 250V AC(rms)/DC
Contact Resistance: 20 mΩ Max
Insulation Resistance: 500 MΩ MIN
Withstanding Voltage: 100V AC r.m.s
Temperature Range—Operating: -25°C~+85°C

Material and Plating

Housing: PA6T(UL 94V-0)
Contact Pin: Phosphor Bronze
Plating: Gold Plated/Selective gold in contact area, matte(bright) tin on tail

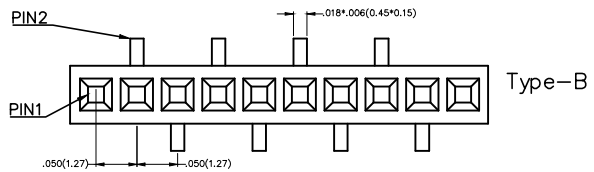
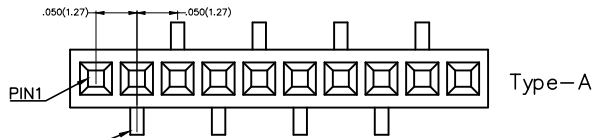

Packing: M—Reel(With Cap)

Packing: M1—Reel(With Mylar)

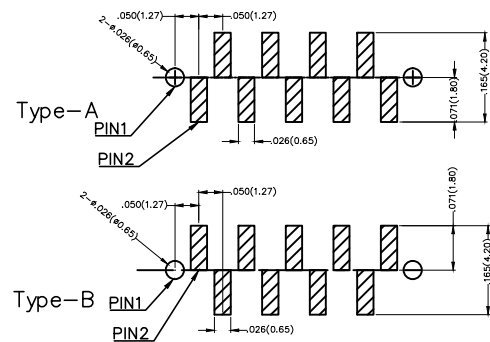
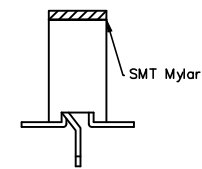
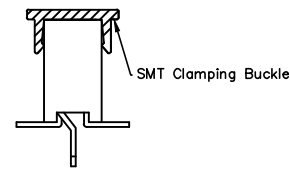
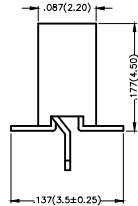
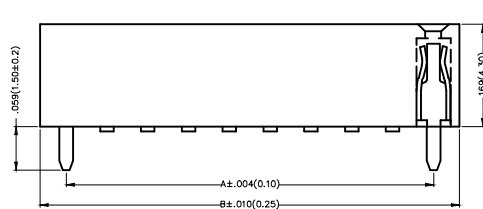

Recommended P.C.Board Layout
Tolerances: .002(±0.05)



Ordering Information

FFH 127 29 — S XX S X XX 4 K6 X — X
1 2 3 4 5 6 7 8 9 10 11 12

1 Category FFH—Female Header	2 Series Number 127—Pitch1.27mm	3 Distinction No. 29	4 Row Option S—Single row	5 Circuits XX	6 Entry Angle S—180° Vertical	7 Plating 1—Gold Plated 3—Selective gold in contact area, matte(bright) tin on tail
8 Thickness of Plating 00—Gold Flash 05—5μ Custom plate available	9 Material—Resin 4—PA6T	10 Color—Resin K6—Black	11 Packaging M—Reel(With Cap) M1—Reel(With Mylar) L—Tube	12 Type A TYPE —A B TYPE —B		

THIRD ANGLE PROJECTION	GENERAL TOLERANCES (UNLESS SPECIFIED)		APPROVE BY FRANK	DATE 10/JUL/13	PART NO. FFH12729—SXSSXXX4K6X—X	ITEM NO. FFH12729	
	DESIGN UNITS Inch (metric)	X.±.012(0.30) X.±5° X.X±.008(0.20) .X'±2°	CHECKED BY CHERRY	DATE 10/JUL/13	TITLE Board to Board (Female Header) Pitch 1.27mm 180° Vertical	REV 0	
SCALE 5:1	SIZE A4	X.XX±.006(0.15) .XX'±1° X.XXX±.004(0.10) .XXX'±0.5°	DRAWN BY JACOB	DATE 10/JUL/13	THIS DRAWING CONTAINS INFORMATION THAT IS PROPRIETARY TO DONG GUAN LANG LUN(3K-KAMING) ELECTRONIC PRODUCTS CO.,LTD. AND SHOULD NOT BE USED WITHOUT WRITTEN PERMISSION		

REV	LOCATIONS	DESCRIPTION	DATE	REVISER	APPD



Circuits (n)	Part No.	Dimensions(in/mm)		Circuits (n)	Part No.	Dimensions(in/mm)	
		A	B			A	B
2	FFH12729-S02SXXX4K6X-X	.050(1.27)	.114(2.89)	22	FFH12729-S22SXXX4K6X-X	1.050(26.67)	1.114(28.29)
3	FFH12729-S03SXXX4K6X-X	.100(2.54)	.164(4.16)	23	FFH12729-S23SXXX4K6X-X	1.100(27.94)	1.164(29.56)
4	FFH12729-S04SXXX4K6X-X	.150(3.81)	.214(5.43)	24	FFH12729-S24SXXX4K6X-X	1.150(29.21)	1.214(30.83)
5	FFH12729-S05SXXX4K6X-X	.200(5.08)	.264(6.70)	25	FFH12729-S25SXXX4K6X-X	1.200(30.48)	1.264(32.10)
6	FFH12729-S06SXXX4K6X-X	.250(6.35)	.314(7.97)	26	FFH12729-S26SXXX4K6X-X	1.250(31.75)	1.314(33.37)
7	FFH12729-S07SXXX4K6X-X	.300(7.62)	.364(9.24)	27	FFH12729-S27SXXX4K6X-X	1.300(33.02)	1.364(34.64)
8	FFH12729-S08SXXX4K6X-X	.350(8.89)	.414(10.51)	28	FFH12729-S28SXXX4K6X-X	1.350(34.29)	1.414(35.91)
9	FFH12729-S09SXXX4K6X-X	.400(10.16)	.464(11.78)	29	FFH12729-S29SXXX4K6X-X	1.400(35.56)	1.464(37.18)
10	FFH12729-S10SXXX4K6X-X	.450(11.43)	.514(13.05)	30	FFH12729-S30SXXX4K6X-X	1.450(36.83)	1.514(38.45)
11	FFH12729-S11SXXX4K6X-X	.500(12.70)	.564(14.32)	31	FFH12729-S31SXXX4K6X-X	1.500(38.10)	1.564(39.72)
12	FFH12729-S12SXXX4K6X-X	.550(13.97)	.614(15.59)	32	FFH12729-S32SXXX4K6X-X	1.550(39.37)	1.614(40.99)
13	FFH12729-S13SXXX4K6X-X	.600(15.24)	.664(16.86)	33	FFH12729-S33SXXX4K6X-X	1.600(40.64)	1.664(42.26)
14	FFH12729-S14SXXX4K6X-X	.650(16.51)	.714(18.13)	34	FFH12729-S34SXXX4K6X-X	1.650(41.91)	1.714(43.53)
15	FFH12729-S15SXXX4K6X-X	.700(17.78)	.764(19.40)	35	FFH12729-S35SXXX4K6X-X	1.700(43.18)	1.764(44.80)
16	FFH12729-S16SXXX4K6X-X	.750(19.05)	.814(20.67)	36	FFH12729-S36SXXX4K6X-X	1.750(44.45)	1.814(46.07)
17	FFH12729-S17SXXX4K6X-X	.800(20.32)	.864(21.94)	37	FFH12729-S37SXXX4K6X-X	1.800(45.72)	1.864(47.34)
18	FFH12729-S18SXXX4K6X-X	.850(21.59)	.914(23.21)	38	FFH12729-S38SXXX4K6X-X	1.850(46.99)	1.914(48.61)
19	FFH12729-S19SXXX4K6X-X	.900(22.86)	.964(24.48)	39	FFH12729-S39SXXX4K6X-X	1.900(48.26)	1.964(49.88)
20	FFH12729-S20SXXX4K6X-X	.950(24.13)	1.014(25.75)	40	FFH12729-S40SXXX4K6X-X	1.950(49.53)	2.014(51.55)
21	FFH12729-S21SXXX4K6X-X	1.000(25.40)	1.064(27.02)				



 THIRD ANGLE PROJECTION	GENERAL TOLERANCES (UNLESS SPECIFIED)		APPROVE BY	DATE	PART NO.	ITEM NO.	 3K-KAMING®
	DESIGN UNITS Inch (metric)	X.±0.12(0.30)	X.±5'	FRANK			
SCALE		SIZE	CHECKED BY	DATE	TITLE		
5:1	A4	CHERRY	10/JUL/13	Board to Board (Female Header) Pitch 1.27mm 180° Vertical		THIS DRAWING CONTAINS INFORMATION THAT IS PROPRIETARY TO DONG GUAN LANG LUN(3K-KAMING) ELECTRONIC PRODUCTS CO.,LTD. AND SHOULD NOT BE USED WITHOUT WRITTEN PERMISSION	
		JACOB					