

特殊符号金属按钮 / Special Symbol Metal Button



■ 特性 / Features

- 防护等级: IP65/IP67/IK10
- 触点银镀金: 3 μ
- LED超高亮冷光源灯显示
- 可定制图案, 颜色及尺寸

符合IEC60947-5-1 GB14048.5标准
Conform to IEC60947-5-1 GB14048.5 Standard

额定参数 / Rated Parameters

工作电压 Working voltage			24V	110V	220V
接触参数 Contact Parameter	AC (50/60Hz)	阻性	—	1.0A	0.5A
		感性	—	0.7A	0.5A
	DC	阻性	1.0A	0.2A	—
		感性	0.7A	0.1A	—

灯珠规格 / Lamp Ratings

灯珠类型Lamp Type	双向LED灯珠(交直流通用) LED lamp(AC/DC)
额定电压Rated Voltage	3V,6V,12V,24V,36V,110V,220VAC/DC
额定电流Rated Current	约7mA 约2mA About 7mA About 2mA
发光颜色LED Color	R G Y O B W
寿命Life	40000小时(参考值) 40000 hours(Reference)
灯珠等效电路 Lamp Circuit diagram	<p>内置电阻; 采用6V灯珠, 需外接电阻。 采用交直流通用的LED灯珠, 接线端子无正负极区分; 60V以下灯珠已内置保护电阻; Using AC/DC LED lamp, the terminals have no difference of anode and cathode; Using inner resistance for the lamp below 60V. Using 6V lamp when the lamp voltage is above 60V, and need connect outer dropping resistance.</p>













注: 如需单向直流LED灯珠可定做; 其他电压规格可按需求定做。 DC LED and other voltage can be made to order.

多种规格、多种颜色



Special Symbol Metal Button

按钮开关型号命名 / Pushbutton Select Code

							
安装尺寸 Install Size	动作方式 Action Style	头部形状 Shape of Top	触点形式 Contact Type	符号形式 Symbol Type	颜色 Color	电压 Voltage	材料 Material
12mm 16mm 19mm 22mm 25mm 28mm 30mm 40mm	2:自复按钮 3:自锁按钮 2:Momentary 3:Maintained	6:高面带灯 7:环面带灯 6:High Ring Illumated 7:Ring Illumated	1:1NO+1NC 2:2NO+2NC	SZ1-10:数字符号 P:电源符号 S:SOS符号 DB:门铃符号 L:灯泡符号 JT:箭头符号 AK:感叹符号 K:警示符号 SZ1-10: Number P: Power Supply S: SOS DB: Doorbell L: Light bulb JT: Arrow AK: Exclamatory mark K: Warning	 红色 / Red  绿色 / Green  蓝色 / Blue  白色 / White  黄色 / Yellow  橘色 / Orange	D:24VDC E:12VDC F:6.3VDC A1:110VAC A2:220VAC	空:不锈钢 T:铜镀铬 Nil:Stainless steel T: Copper plated Cr







注: 常规的定制都是不锈钢外壳, 如需铜镀铬外壳, 请在型号后面加T。

Note: The regular material is Stainless steel, if you want Copper Plated Cr, please add T behind.

触点规格 / Contact Ratings

额定绝缘电压/Rated insulation voltage	250V					
发热电流/Heating current I _{th}	3A温度不超过最大额定值所允许的电流 Temperature does not exceed the maximum allowed current					
额定使用电压/Rated voltage	12V	24V	110V	220V		
额定使用电流 Rated current	交流AC 50/60Hz	电阻性负载 Resistive load	-	5A	3A	
		电感性负载 Inductive load	-	3A	2A	
	直流DC	电阻性负载 Resistive load	5A	5A	1A	0.5A
		电感性负载 Inductive load	2A	2A	0.2A	0.1A
触点材料/Contact material	银氧化镍/Silver nickel oxide		银镀金/Silver Plated Gold			

触点结构 / Contact Structure

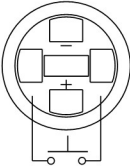
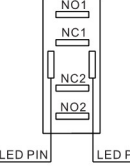
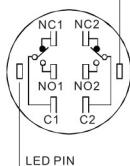
型式Type	No.1	No.2	No.3
符号Sign			
示意图 Diagram			
端子描述 Terminal Description			
说明 Explanation	具有两个端子的双断电慢动触头开关个别产品可定制Y型常闭开关, 详见产品说明 Using two terminals, double-break and slow-motion contact. Y type NC switch can be made to order for individual product, pls check the product description.		

电源符号金属按钮/Power symbol metal button

名称/外观 Product appearance	带灯形式 Illuminated type	操作类别 Operation	触点 Contact	产品型号 Model	带灯颜色 Color	额定电压 Rated Voltage	外壳材料 Crust Material
电源符号 / Power Supply 	带灯 With LED	自复 Momentary	1NO+1NC	J25-271P □●	请用下列颜色编码 替换型号中的"□" R 红色/Red G 绿色/Green Y 黄色/Yellow W 白色/White B 蓝色/Blue O 橘色 / Orange	请用下列颜色编码 替换型号中的"●" D:24VDC E:12VDC F:6.3VDC A1:110VAC A2:220VAC	空:不锈钢 T:铜镀铬 Nil:Stainless steel T: Copper plated Cr
			2NO+2NC	J25-272P □●			
		自锁 Maintained	1NO+1NC	J25-371P □●			
			2NO+2NC	J25-372P □●			

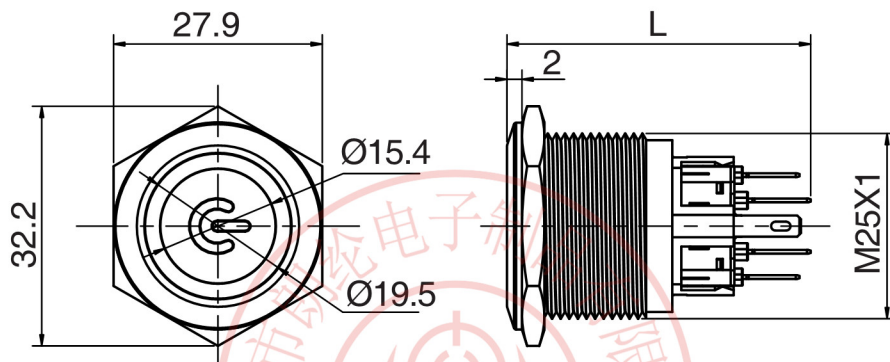

L: 自复:40.6
自锁:42.25

