

EJ-M超短款金属按钮 / Ultra Short Metal Button



■ 特性 / Features

- 安装直径12/16/19/22/25mm
- 防护等级: IP67/IP68/IK10
- 弹片: 不锈钢材质
- LED超高亮冷光源灯显示
- 专用特殊磨砂不锈钢环, 整体
- 超短行程: $\leq 0.5\text{mm}$

符合IEC60947-5-1 GB14048.5标准
Conform to IEC60947-5-1 GB14048.5 Standard















主要技术参数 / Technical Parameter

保护等级/Degree of Protection	IP67/IP68
触点类型/Contact Type	1 NO
额定电压/Rated Voltage	DC36V
额定电流/Rated Current	2A
最小负载/Minimum Applicable Load	3V AC/DC, 1mA
触点材料/Contact material	Silver plated
运行温度/Operating Temperature	-25° to +55°C
操作湿度/Operating Humidity	45 to 85% RH
接触电阻/Contact Resistance	$\leq 50\text{m}\Omega$
绝缘电阻/Insulation Resistance	$\leq 50\text{m}\Omega$
震荡电阻/Vibration Resistance	10 to 55Hz, amplitude 1.2mm p-p
保护等级/Degree of Protection	>10g
电气寿命/Electrical Life	200,000 operations minimum (at full rated load)
机械寿命/Mechanical Life	1,000,000 operations minimum
耐压/Dielectrical Life	Switch Unit: 2,000V AC, 1 min. between live/dead part and terminals of different poles; 1,000V AC, 1 minute between terminals of the same pole; 1,500V AC, 1 minute between contact and lamp terminals. Illumination Unit: 2,000V AC, 1 min. between live part/ground
连接形式/Connection Form	Foot welding
锡焊温度/Soldering Temperature	20W/5 seconds or 260°C/3 seconds
拧紧力矩/Tightening Torque	5-14N.m
动作行程/Action Stroke	$\leq 0.5\text{mm}$
动作力/Action Force	$\leq 3\text{N}$

尺寸超短、行程超短





按钮开关型号命名 / Pushbutton Select Code

	—						—		
安装尺寸 Install Size		动作方式 Action Style:	头部形状 Shape of Top:	触点形式 Contact Type:	安装方式 Install Style:	颜色/Color:		电压/Voltage:	材料/Material:
12mm 16mm 19mm 22mm 25mm		2:自复按钮 2: Momentary	1: 平头 7: 环面带灯 1: Flat Round 7: Ring Illuminated	1:1NO	A: 螺丝型 Screw Type P: 焊线型 PCB Type	 红色 / Red  绿色 / Green  蓝色 / Blue  白色 / White  黄色 / Yellow  橘色 / Orange		D:24VDC E:12VDC F:6.3VDC G:3VDC	空: 不锈钢 A: 铝 T: 铜镀铬 Ni: Stainless steel Al: Aluminium T: Copper plated Cr

注：常规的定制都是不锈钢外壳，如需铜镀铬外壳，请在型号后面加T。

Note: The regular material is Stainless steel, if you want Copper Plated Cr, please add T behind.

灯珠规格 / Lamp Ratings

灯珠类型/Lamp Type	LED灯珠(直流) LED lamp(DC)
额定电压/Rated Voltage	3V,6V,12V,24V
额定电流/Rated Current	约15mA 约2mA About 15mA About 2mA
发光颜色/LED Color	
寿命/Life	50000小时(参考值) 50000 hours(Reference)
灯珠等效电路/Lamp Circuit diagram	 <p>内置电阻; 采用0603贴片灯珠。 Built in resistors; use 0603 patch beads.</p>
功率/Power	0.06W
显色指数/Chromogenic index	60-70
光通量/Luminous flux	80-100mcd(lm)
正向电压/Forward voltage	2.0-3.2V
反向电压/Reverse voltage	3V
静电击穿电压 (ESD) Electrostatic breakdown voltage	3000V
额定电流/Rated current	0.006A
发光角度/Lighting angle	120°
发光效率/Luminous efficiency	110(lm/W)
热阻/thermal resistance	≤50°C/W
最大允许结温 Maximum allowable junction temperature	120°C
老化时间/Ageing time	1000小时常规老化100%; 6000小时常规老化98% 1000 hours of conventional aging 100%; 6000 hours conventional aging 98%

触点示意图 / Contact Diagram

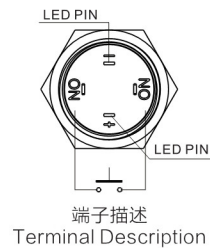
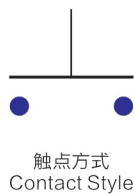

EJ-M超短款金属按钮

RoHS SGS cRU[®]us CCC CE

EJ-M超短款金属按钮/Ultra short metal button

名称/外观 Product appearance	带灯形式 Illuminated type	操作类别 Operation	触点 Contact	产品型号 Model	外壳材料 Crust Material
平面圆形 / Domed round 	带灯 With LED	自复 Momentary	1NO	EJ22-211PM	空:不锈钢 A:铝 G:铜镀铬 Nil:Stainless steel A: Aluminium T: Copper plated Cr

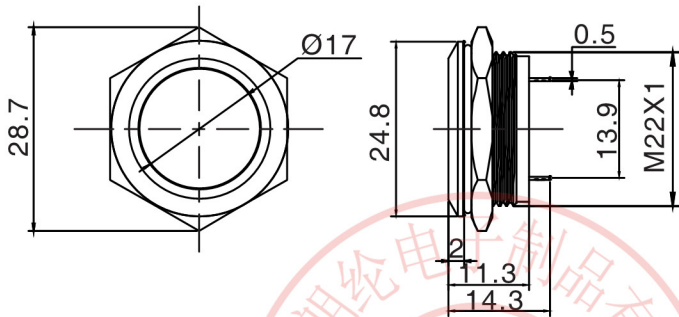

名称/外观 Product appearance	安装形式 Install Style	操作类别 Operation	触点 Contact	产品型号 Model	颜色 Color	额定电压 Rated Voltage	外壳材料 Crust Material
环面带灯 / Domed round 	焊线型 PCB Type	自复 Momentary	1NO	EJ22-271PM□●	请用下列颜色编码 替换型号中的"□" R 红色/Red G 绿色/Green Y 黄色/Yellow W 白色/White B 蓝色/Blue O 橘色 / Orange	请用下列颜色编码 替换型号中的"●" D:24VDC E:12VDC F:6.3VDC A1:110VAC A2:220VAC	空:不锈钢 A:铝 T:铜镀铬 Nil:Stainless steel A: Aluminium T: Copper plated Cr

