

REV	LOCATIONS	DESCRIPTION	DATE	REVISER	APPD
1	△	Part No.: Change FRJ45123 into FRJ45032	31/MAY/18	KATE	ERIC
2	△	Add dimensions	28/NOV/18	KATE	ERIC



SPECIFICATIONS

Electrical

Current Rating: 1.5A AC(rms)/DC  
Voltage Rating: 125V AC(rms)/DC  
Contact Resistance: 30 mΩ Max  
Insulation Resistance: 500 MΩ Min / DC 500V  
Withstanding Voltage: 1000V AC r.m.s  
Operating Temperature: -40°C~+85°C

Material and Plating

Housing: PA46, 94V-0 ,Black  
Insert: PBT, 94V-0 ,Black  
Contact: Phosphor Bronze/Gold Plated  
Shell: Brass,T=0.20mm/Nickel Plated

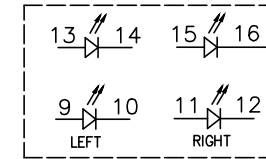
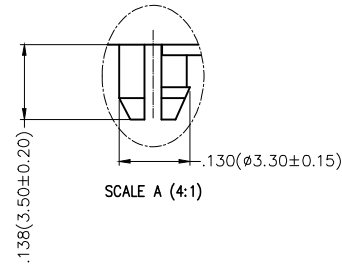

Ordering Information

FRJ45 032 - 8 1 XX K6 K X 2 0 0  
1 2 3 4 5 6 7 8 9

1 Category FRJ45-RJ45 Connector	2 Distinction No. 032	3 Ports options 8-8 Ports	4 Plating 1-Gold Plated	5 Thickness of plating 00-Gold flash 03-3μ" Custom plate available
6 Color-Resin K6-Black	7 Packaging K- Tray	8 LED style 1-L: Yellow R: Green 2-L: Green R: Yellow	9 Contact type 2-Round pin	

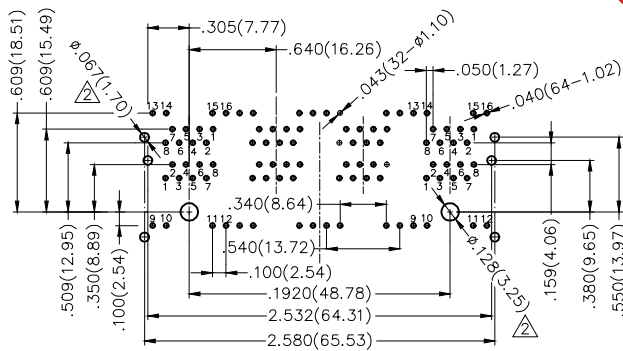
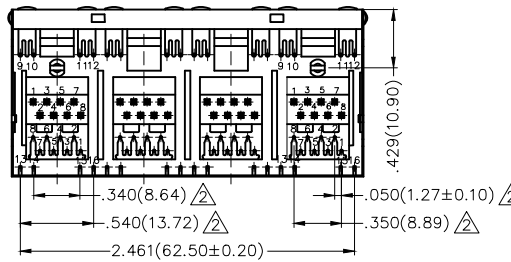
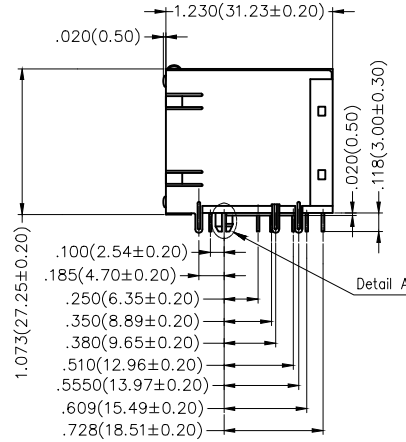
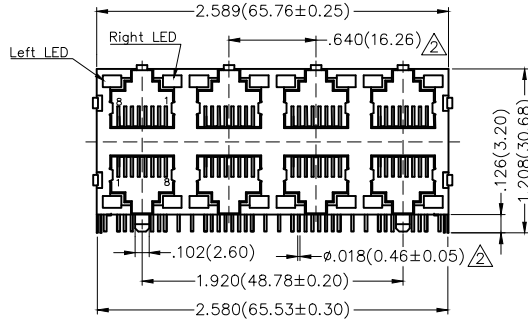
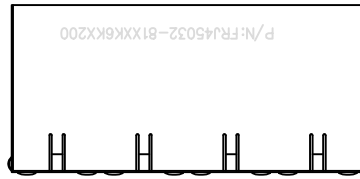

Recommended P.C.Board Layout

THIRD ANGLE PROJECTION	GENERAL TOLERANCES (UNLESS SPECIFIED)		APPROVE BY FRANK	DATE 18/JUN/13	PART NO. △ FRJ45032-81XXK6KX200	ITEM NO. FRJ45032	
	X.±.012(0.30)	X.±5'	CHECKED BY CHERRY	DATE 18/JUN/13	TITLE RJ45 Connectors 8P8C 90°Angle	REV 2	
DESIGN UNITS Inch (metric)	X.X±.008(0.20)	.X'±2'	DRAWN BY KEVIN	DATE 18/JUN/13	THIS DRAWING CONTAINS INFORMATION THAT IS PROPRIETARY TO DONG GUAN LANG LUN(3K-KAMING) ELECTRONIC PRODUCTS CO.,LTD. AND SHOULD NOT BE USED WITHOUT WRITTEN PERMISSION		
SCALE 5:1	SIZE A4	X.XX±.006(0.15)					
		X.XXX±.004(0.10)					