

△				
△				
△				
△				
ZONE	REV	DESCRIPTION	DATE	APPD.

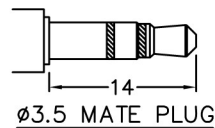

**RoHS**  
**Compatible**

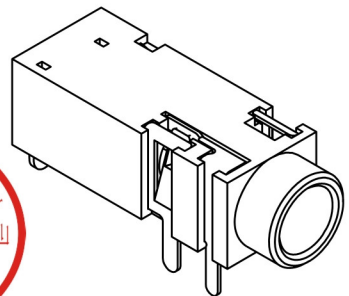
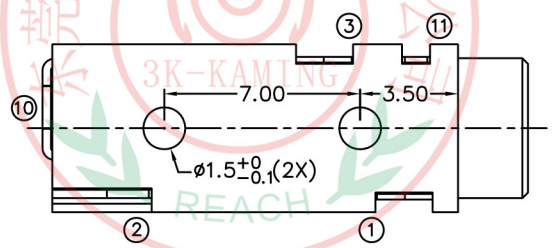
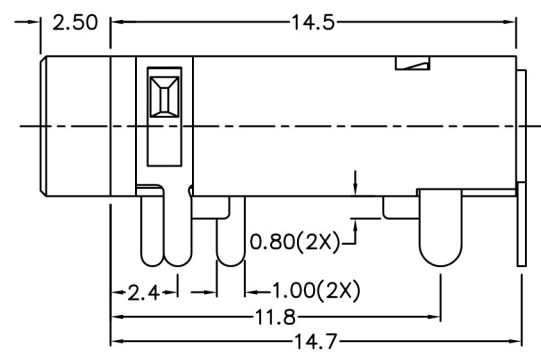
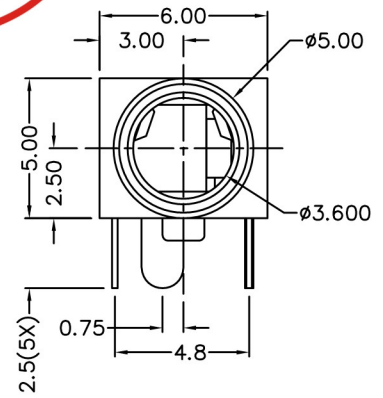
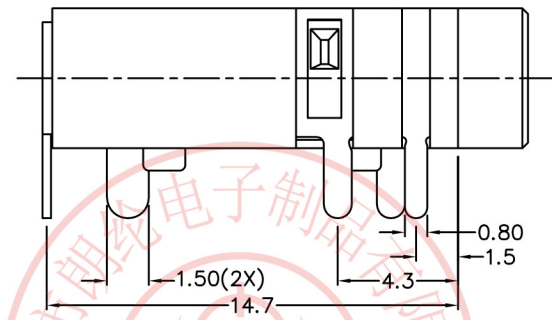

**\* MATERIAL**  
 TERMINAL 1 : COPPER ALLOY  
 TERMINAL 2 : COPPER ALLOY  
 TERMINAL 3 : COPPER ALLOY  
 TERMINAL 10 : BRASS  
 TERMINAL 11 : BRASS  
 HOUSING : PA66

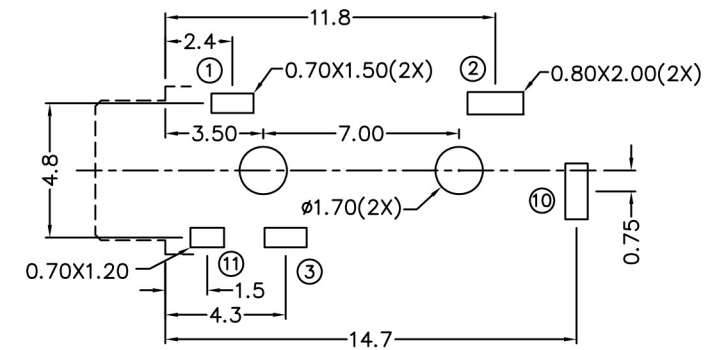

RECOMMENDED  
(BOTTOM VIEW)



MODEL NO.	PJ-3765	PJ-3764A	PJ-3764B	PJ-3763	PJ-3763A	PJ-3762
SCHEMATIC						

**3K-KAMING** 东莞市朗纶电子制品有限公司  
 Dongguan langlun electronic products Co., Ltd

TEL: 86-0769-82123233 FAX: 86-0769-83536433

DESIGN	Will	SCALE		
DRAWING	Will	UNIT	mm	
CHECK	Will	SIZE	A4: 210*297	
APPROVAL	Eric	VERSION	01	

TOLERANCE UNLESS OTHERWISE STATED(mm)
less than 10 — ±0.2
10~30 — ±0.3
30~100 — ±0.5
ANGLE — ±2°

PART NAME	PHONE JACK
PART NO	PJ-376 SERIES
DRAWING NO	
DATE	2009/11/25