

△				
△				
△				
△				
ZONE	REV	DESCRIPTION	DATE	APPD.

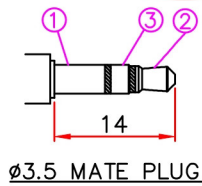

RoHS
Compatible

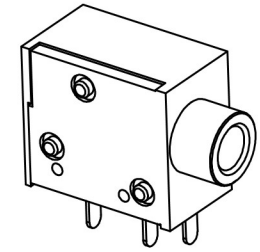
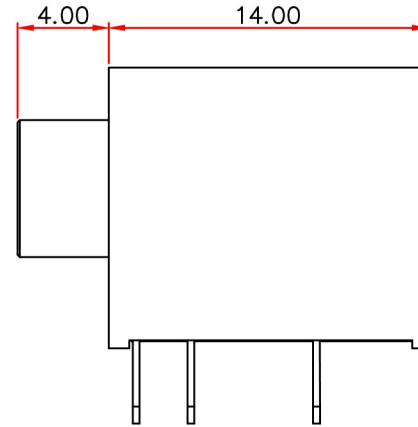
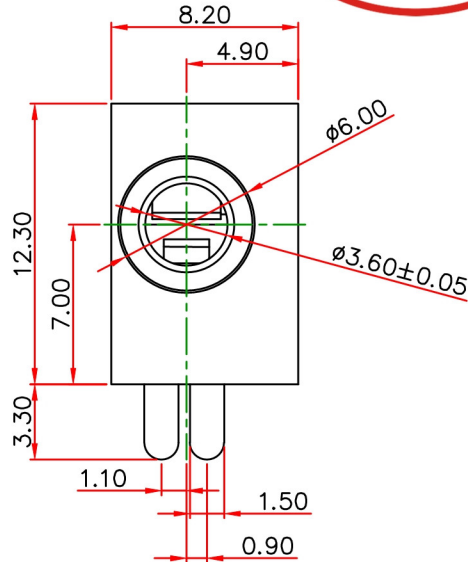
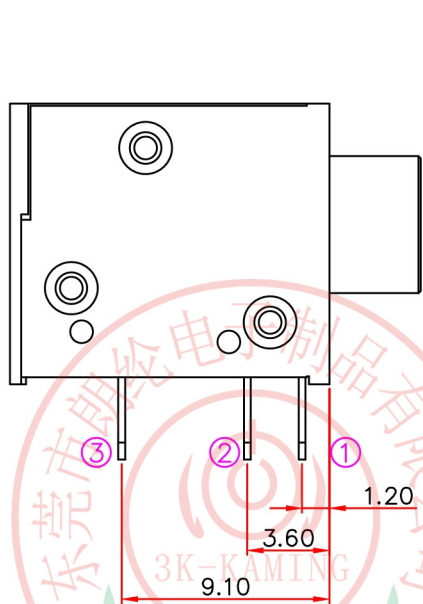

Material :
Terminal 1 : Copper Alloy
Terminal 2 : Brass
Terminal 3 : Brass
Spring : Stainless steel
Plastic : PBT

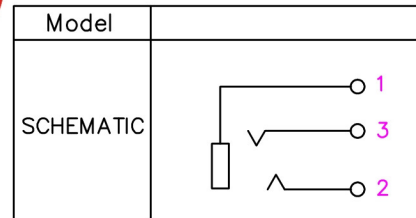

RECOMMENED P.C.B MOUNTING
PATTERN DIMENSION

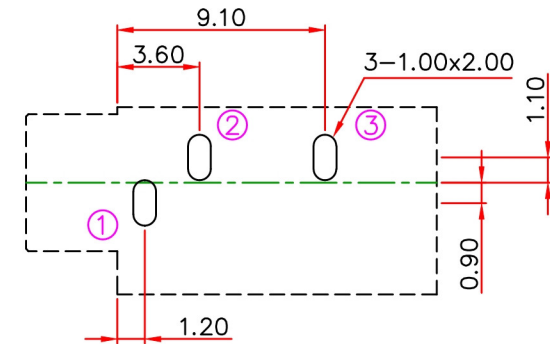

3K-KAMING 东莞市朗纶电子制品有限公司
Dongguan langlun electronic products Co., Ltd

TEL: 86-0769-82123233 FAX: 86-0769-83536433

DESIGN	Eason	SCALE		
DRAWING	Eason	UNIT	mm	
CHECK	Eason	SIZE	A4: 210*297	
APPROVAL	Honda	VERSION	01	

TOLERANCE UNLESS OTHERWISE STATED(mm)	
0	±0.30
0.0	±0.25
0.00	±0.20
ANGLE	±2°

PART NAME	PHONE JACK
PART NO	PJ-3633
DRAWING NO	
DATE	2018/06/11