

**RoHS**  
**Compatible**

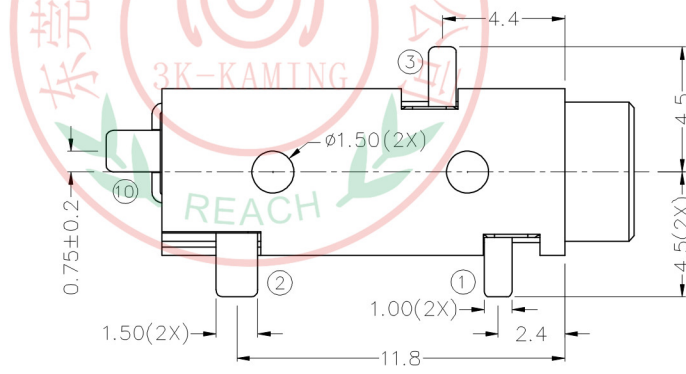

△				
△				
△				
△				
ZONE	REV	DESCRIPTION	DATE	APPD.

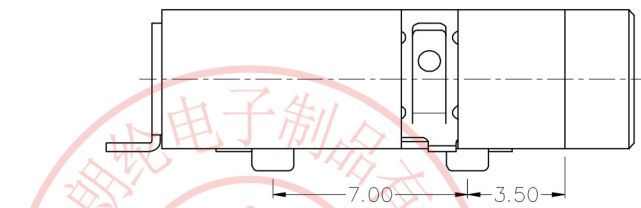
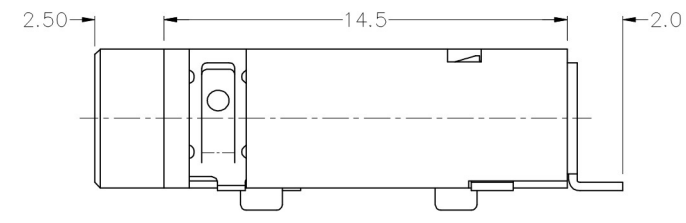
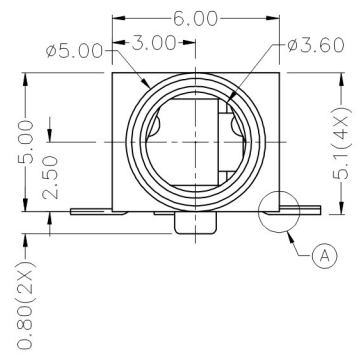
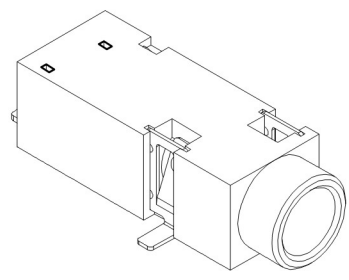

**Material :**  
 TERMINAL 1 : Copper Alloy, Ag Plated  
 TERMINAL 2 : Copper Alloy, Ag Plated  
 TERMINAL 3 : Copper Alloy, Ag Plated  
 TERMINAL 10 : Brass, Ag Plated  
 HOUSING : PA10T

- Specifications**
- Rating : DC 12V, 1A Max.
  - Contact resistance : 50mΩ Max (initial), after life test 100mΩ Max.
  - Insulation resistance : 100MΩ Min (initial), after environmental test 50MΩ Min.
  - Insertion and Withdrawal force : 0.3~3Kgs at initial. and 0.2~2Kgs after life test.
  - Operating life : 5,000 cycles.

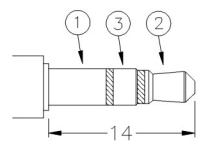
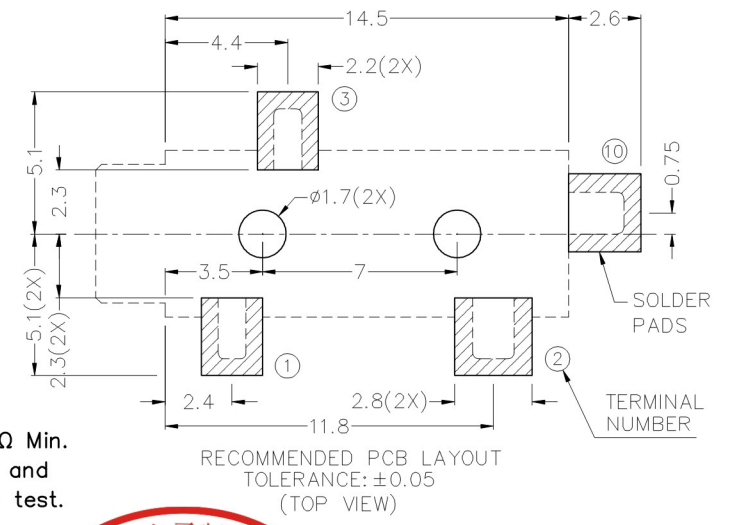

ø3.5 MATE PLUG

MODEL NO.	PJ-3874D	PJ-3873D	PJ-3873AD
SCHEMATIC			



**3K-KAMING** 东莞市朗纶电子制品有限公司  
 Dongguan langlun electronic products Co., Ltd  
 TEL: 86-0769-82123233 FAX: 86-0769-83536433

DESIGN	Sean	SCALE		
DRAWING	Sean	UNIT	mm	
CHECK	Sean	SIZE	A4: 210*297	
APPROVAL	Honda	VERSION	02	

TOLERANCE UNLESS OTHERWISE STATED(mm)	PART NAME	PHONE JACK
0 _____ ±0.50	PART NO	PJ-387D SERIES
0.0 _____ ±0.25	DRAWING NO	
0.00 _____ ±0.15	DATE	2017/06/23
ANGLE _____ ±2°		