

▲				
▲				
▲				
▲				
ZONE	REV	DESCRIPTION	DATE	APPD.

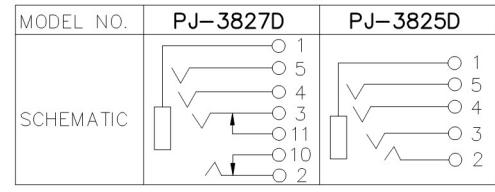

RoHS
Compatible

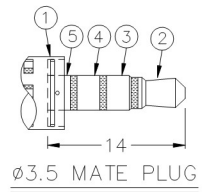
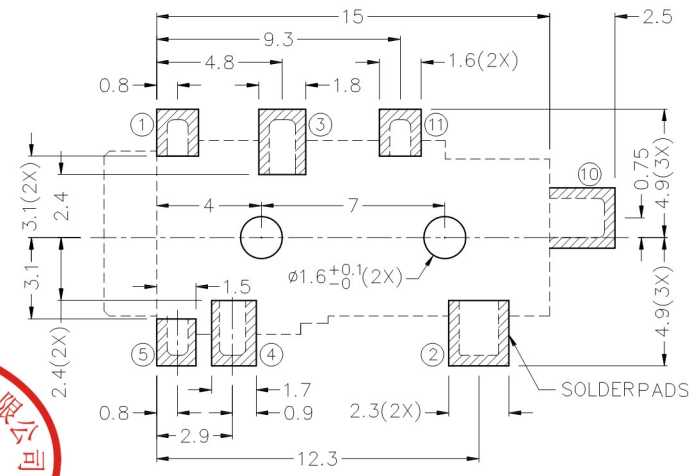
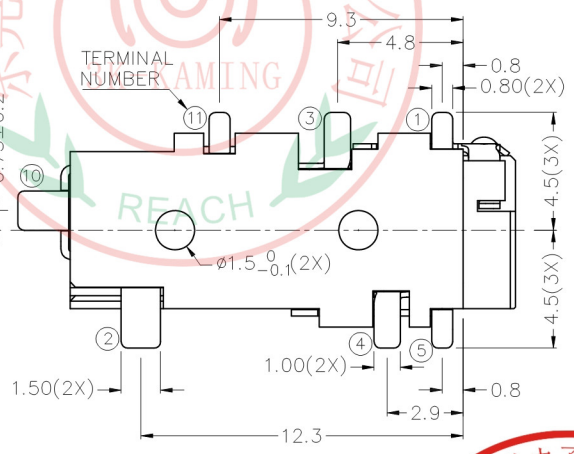
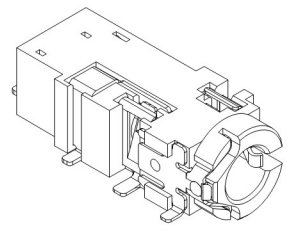
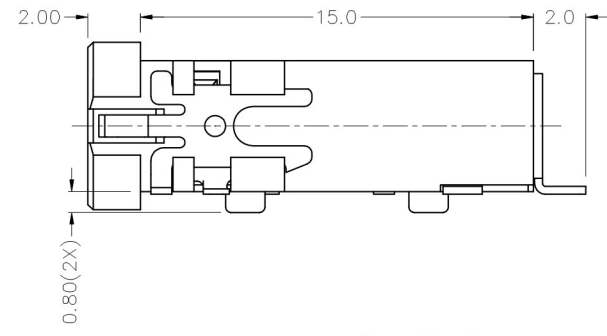
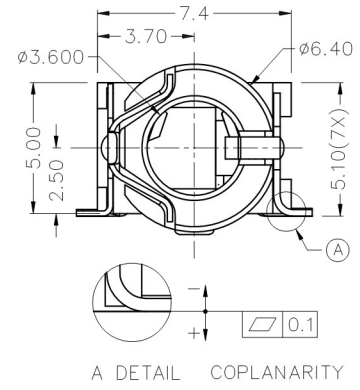
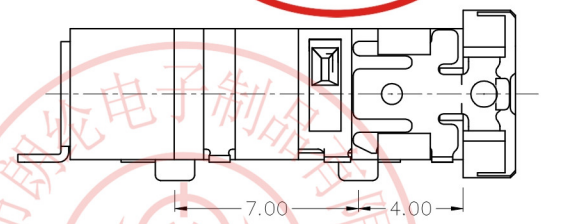

Specification

- Rating : DC 12V, 1A.
- Contact resistance : ≤ 50mΩ;
After test: ≤100mΩ.
- Insulation resistance : ≥100MΩ (500 VDC)
After test: ≥50MΩ.
- Withstand voltage : 500VAC.
- Insertion and extraction force : 3N~30N.
- life test : 5,000 cycles min.
- Operation temperature range: -25°C~85°C

8	Terminal 11	Brass	1	Ag Plated
7	Terminal 10	Brass	1	Ag Plated
6	Terminal 5	Copper Alloy	1	Ag Plated
5	Terminal 4	Copper Alloy	1	Ag Plated
4	Terminal 3	Copper Alloy	1	Ag Plated
3	Terminal 2	Copper Alloy	1	Ag Plated
2	Terminal 1	Copper Alloy	1	Ag Plated
1	Housing	PA10T	1	Black
No.	Part Name	Material	Q'ty	Remarks



3K-KAMING 东莞市朗纶电子制品有限公司
Dongguan langlun electronic products Co., Ltd

DESIGN	Jeff	SCALE		
DRAWING	Jeff	UNIT	mm	
CHECK	Jeff	SIZE	A4: 210*297	
APPROVAL	Honda	VERSION	02	

TOLERANCE UNLESS OTHERWISE STATED(mm)	
0	±0.30
0.0	±0.20
0.00	±0.10
ANGLE	±2°

PART NAME	PHONE JACK
PART NO	PJ-382XD Series
DRAWING NO	
DATE	2017/01/19

TEL: 86-0769-82123233 FAX: 86-0769-83536433