

△				
△				
△				
△				
ZONE	REV	DESCRIPTION	DATE	APPD.

Order information
PJ-381xD-HF

X=> schematic
4 = 4 pin
3 = 3 pin without switch function
3A = 3 pin with switch function

HF
Halogen Free

RoHS
Compatible

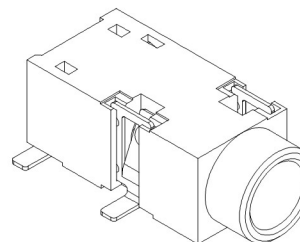

ø3.5 MATE PLUG

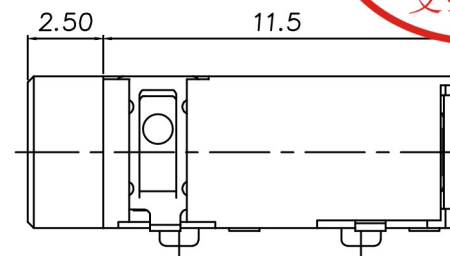
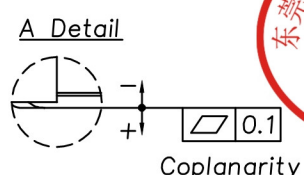
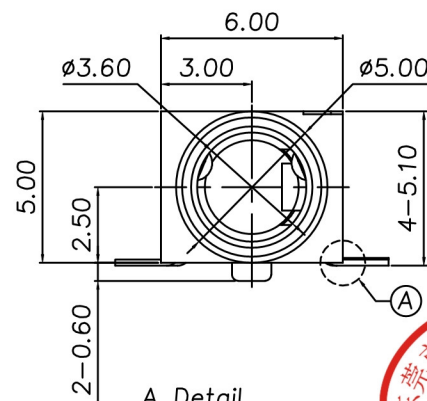
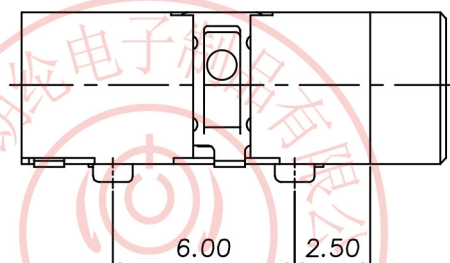
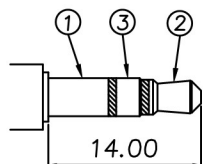

P.C.B Mounting
Pattern Dimension
Tolerance : ±0.05
(Top View)



***MATERIAL**

Terminal 1 : Copper alloy
Terminal 2 : Copper alloy
Terminal 3 : Copper alloy
Terminal 10 : Copper alloy
Housing : PA10T

Model NO.	PJ-3814D	PJ-3813D	PJ-3813AD
Schematic			

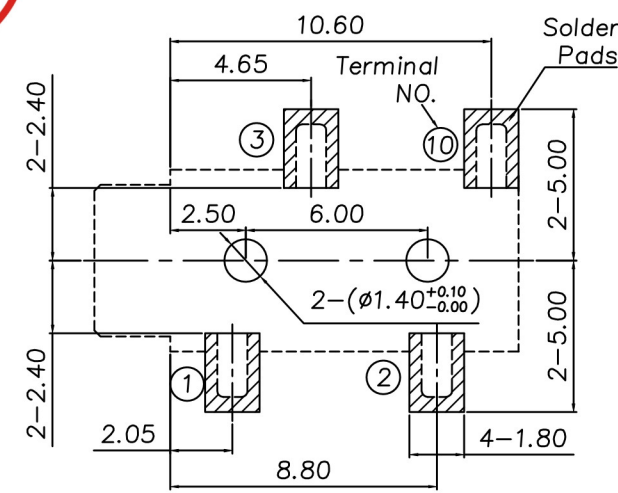
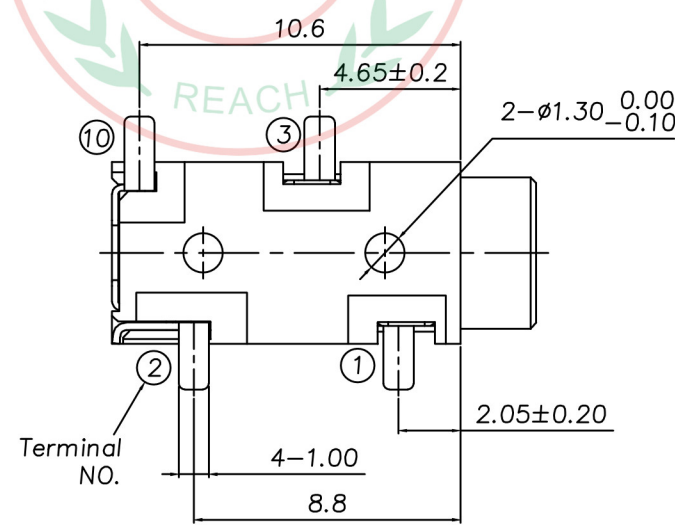

3K-KAMING 东莞市朗纶电子制品有限公司
Dongguan langlun electronic products Co., Ltd
TEL: 86-0769-82123233 FAX: 86-0769-83536433

DESIGN	Sean	SCALE		
DRAWING	Sean	UNIT	mm	
CHECK	Sean	SIZE	A4: 210*297	
APPROVAL	Honda	VERSION	02	

TOLERANCE UNLESS OTHERWISE STATED(mm)	
0	±0.5
0.0	±0.2
0.00	±0.15
ANGLE	±2'

PART NAME	PHONE JACK
PART NO	PJ-381xD-HF SERIES
DRAWING NO	
DATE	2016/02/26