

**RoHS**  
**Compatible**

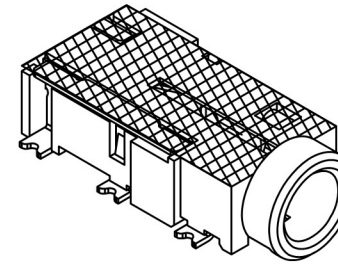

△				
△				
△				
△				
ZONE	REV	DESCRIPTION	DATE	APPD.

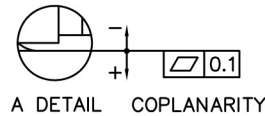
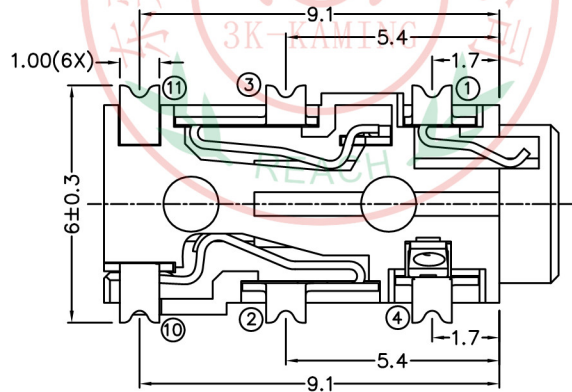
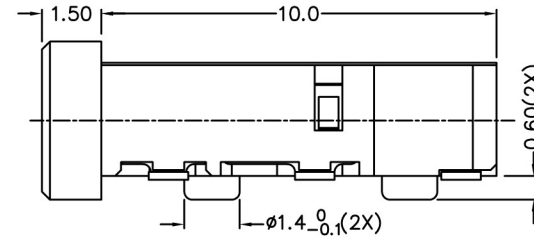
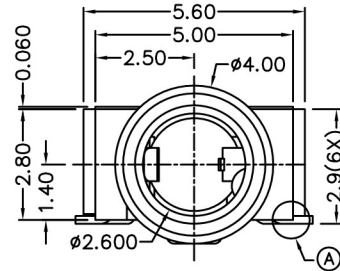
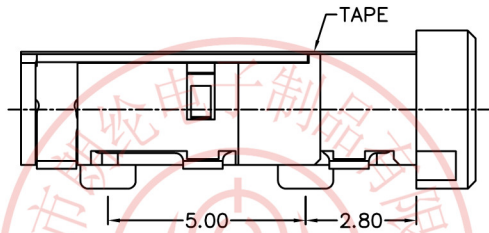

**\* MATERIAL**

- TERMINAL 1 : COPPER ALLOY
- TERMINAL 2 : COPPER ALLOY
- TERMINAL 3 : COPPER ALLOY
- TERMINAL 4 : COPPER ALLOY
- TERMINAL 10 : COPPER ALLOY
- TERMINAL 11 : COPPER ALLOY
- HOUSING : PA6T
- TAPE : POLYIMIDE

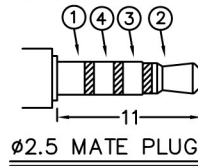
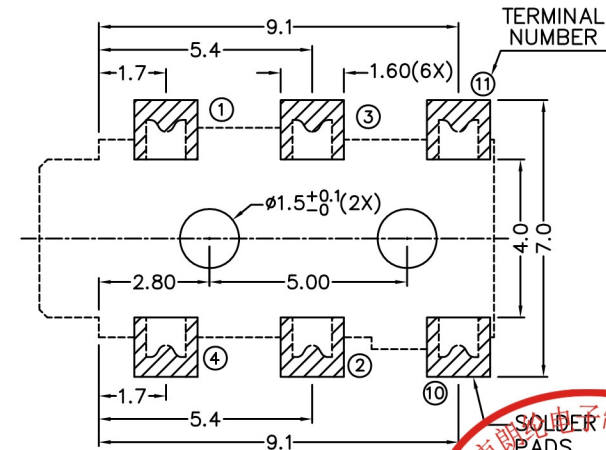

MODEL NO.	PJ-2966DT1	PJ-2965ADT1	PJ-2965BDT1	PJ-2964DT1
SCHMATIC				



**3K-KAMING** 东莞市朗纶电子制品有限公司  
Dongguan langlun electronic products Co., Ltd  
TEL: 86-0769-82123233 FAX: 86-0769-83536433

DESIGN	Will	SCALE		
DRAWING	Will	UNIT	mm	
CHECK	Will	SIZE	A4: 210*297	
APPROVAL	Eric	VERSION	01	

TOLERANCE UNLESS OTHERWISE STATED(mm)	PART NAME	PHONE JACK
less than 10 — ±0.3	PART NO	PJ-296DT1 SERIES
10~30 — ±0.4	DRAWING NO	
30~100 — ±0.5	DATE	2011/12/14
ANGLE — ±2°		