

RoHS
Compatible

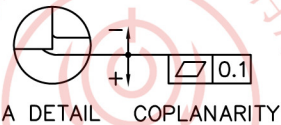

△				
△				
△				
△				
ZONE	REV	DESCRIPTION	DATE	APPD.

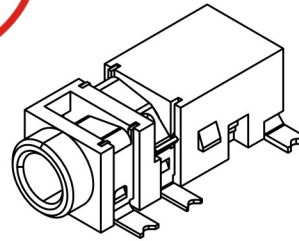
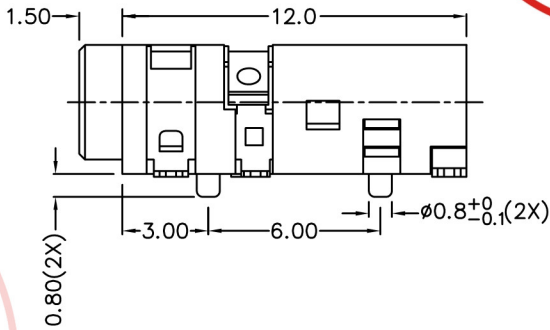
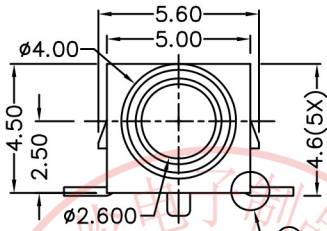

*** MATERIAL**

- TERMINAL 1 : COPPER ALLOY
- TERMINAL 2 : COPPER ALLOY
- TERMINAL 3 : COPPER ALLOY
- TERMINAL 10 : BRASS
- TERMINAL 11 : BRASS
- HOUSING : PA6T

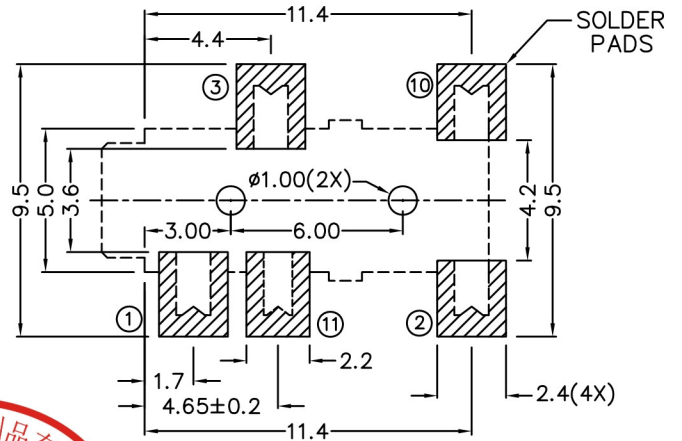
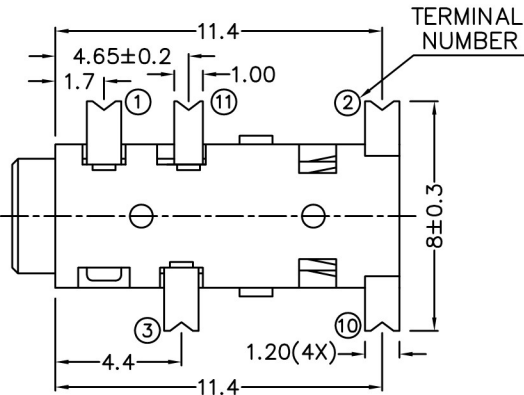
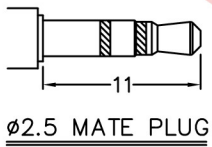

RECOMMENDED
SOLDER PAD LAYOUT



MODEL NO.	PJ-2915D	PJ-2914AD	PJ-2914BD	PJ-2913D	PJ-2913AD
SCHEMATIC					

3K-KAMING 东莞市朗纶电子制品有限公司
Dongguan langlun electronic products Co., Ltd

TEL: 86-0769-82123233 FAX: 86-0769-83536433

DESIGN	Will	SCALE		
DRAWING	Will	UNIT	mm	
CHECK	Will	SIZE	A4: 210*297	
APPROVAL	Eric	VERSION	01	

TOLERANCE UNLESS OTHERWISE STATED(mm)
less than 10 — ±0.2
10~30 — ±0.3
30~100 — ±0.5
ANGLE — ±2°

PART NAME	PHONE JACK
PART NO	PJ-291D SERIES
DRAWING NO	
DATE	2010/03/26