

RoHS
Compatible

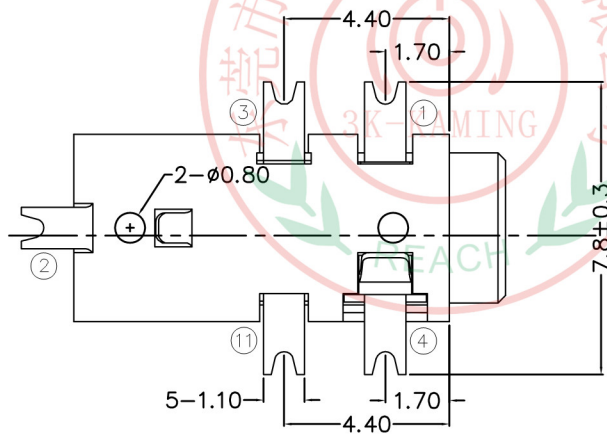

△				
△				
△				
△				
ZONE	REV	DESCRIPTION	DATE	APPD.

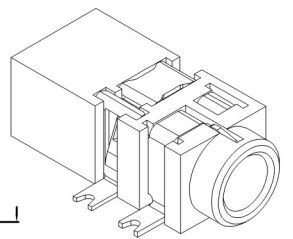
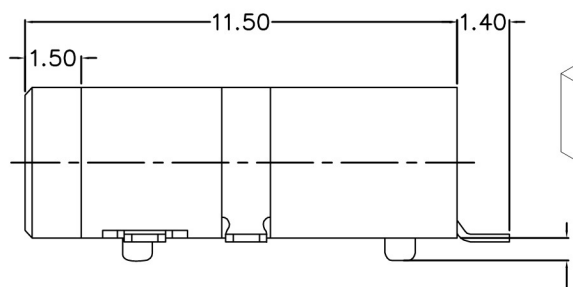
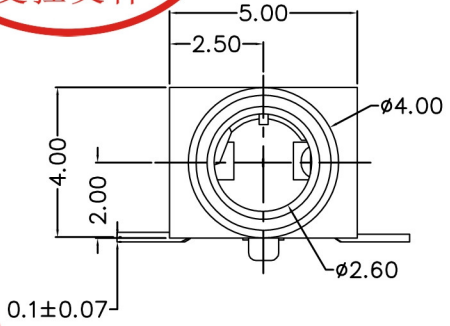
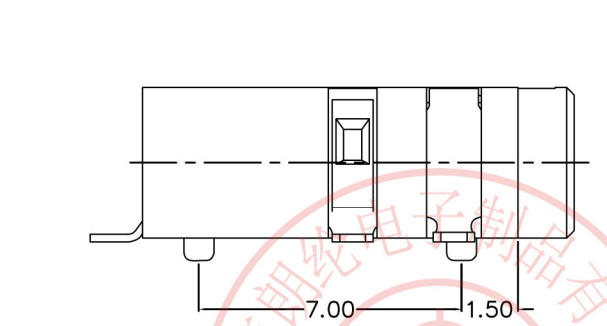

* MATERIAL
 TERMINAL 1 : COPPER ALLOY
 TERMINAL 2 : COPPER ALLOY
 TERMINAL 3 : COPPER ALLOY
 TERMINAL 4 : COPPER ALLOY
 TERMINAL 11 : BRASS
 HOUSING : PA6T

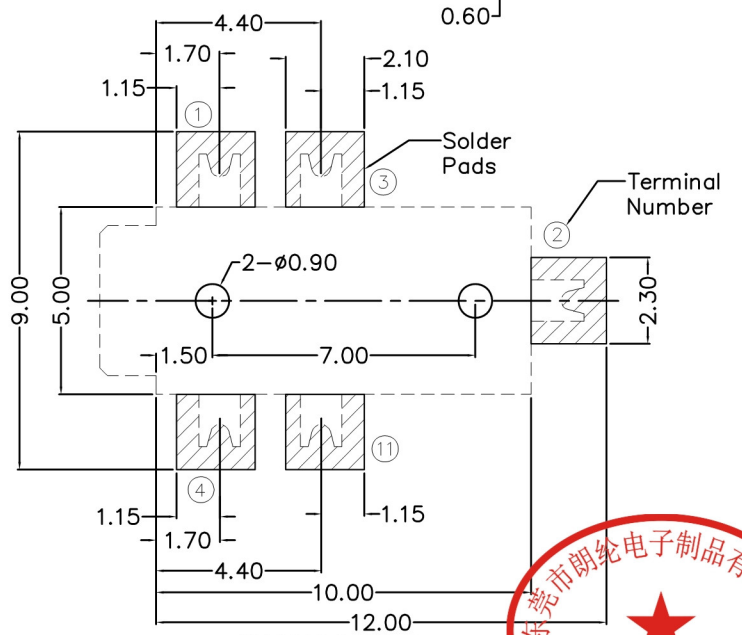

RECOMMENDED
SOLDER PAD LAYOUT

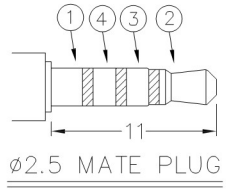

MODEL NO.	PJ-2845D	PJ-2844BD
SCHEMATIC		



3K-KAMING 东莞市朗纶电子制品有限公司
 Dongguan langlun electronic products Co., Ltd
 TEL: 86-0769-82123233 FAX: 86-0769-83536433

DESIGN	Will	SCALE		
DRAWING	Will	UNIT	mm	
CHECK	Will	SIZE	A4: 210*297	
APPROVAL	Eric	VERSION	01	

TOLERANCE UNLESS OTHERWISE STATED(mm)	PART NAME	PHONE JACK
less than 10 — ±0.2	PART NO	PJ-284D SERIES
10~30 — ±0.3	DRAWING NO	
30~100 — ±0.5	DATE	2009/11/24
ANGIE — ±2'		