

REV	LOCATIONS	DESCRIPTION	DATE	REVISER	APPD

A
B
C
D
E
F

A
B
C
D
E
F

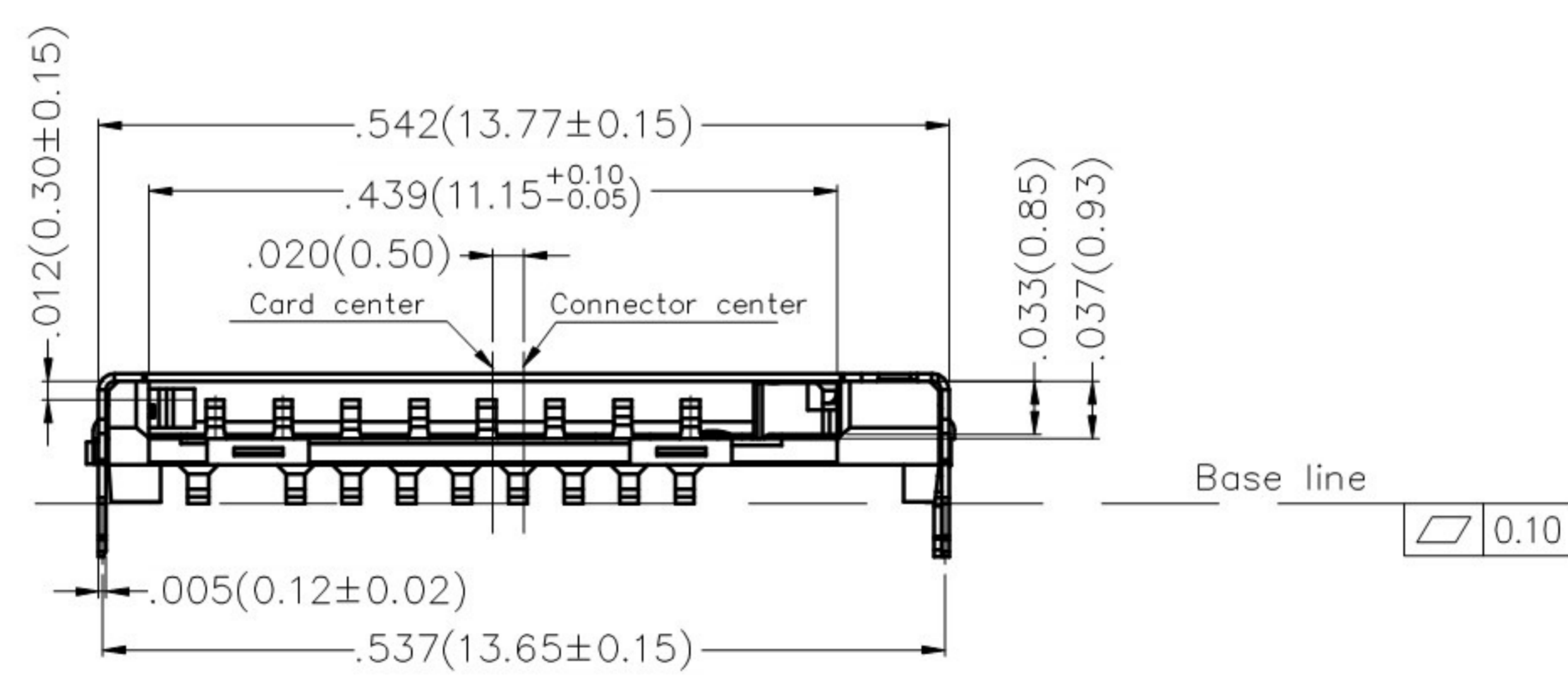
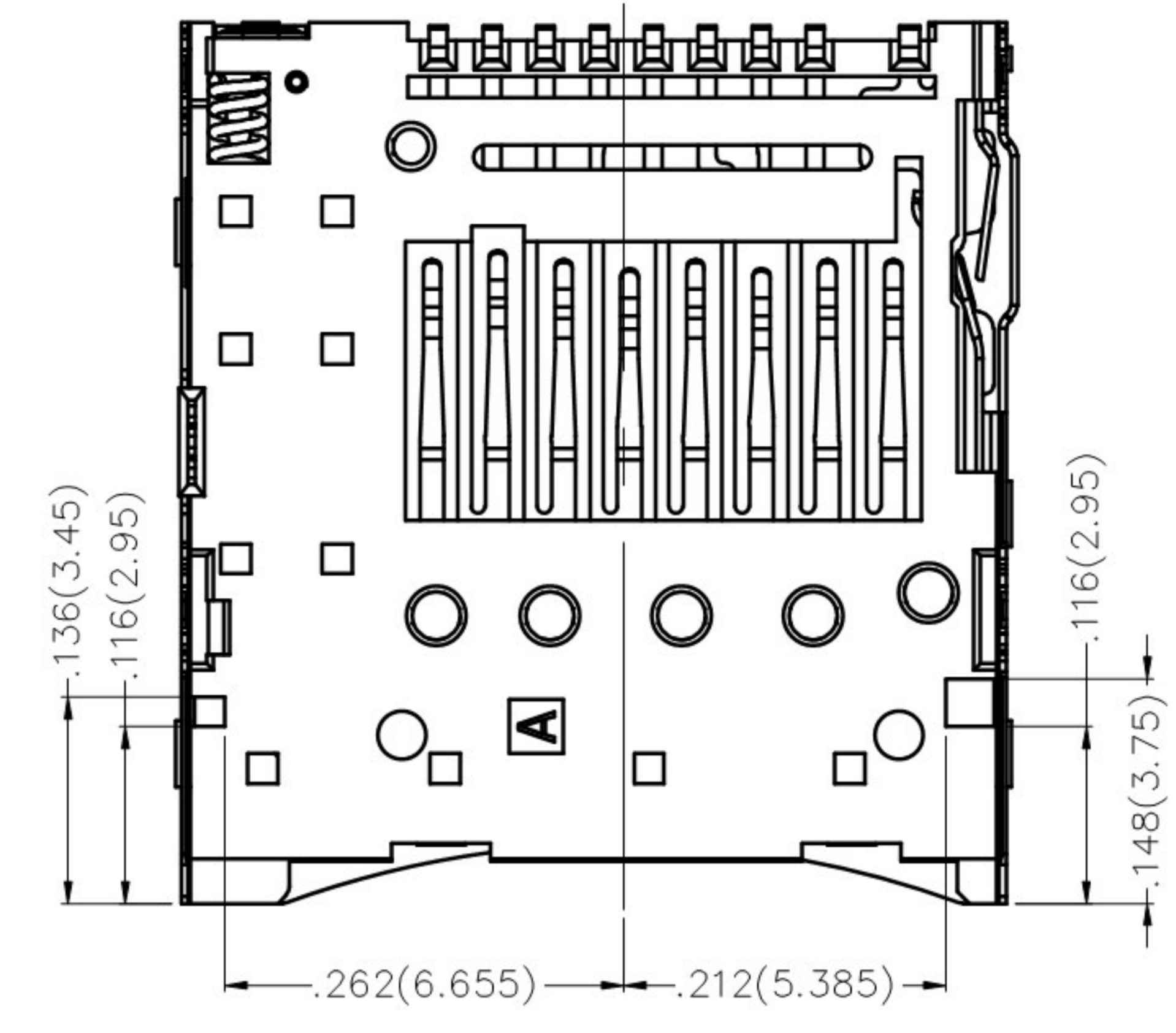
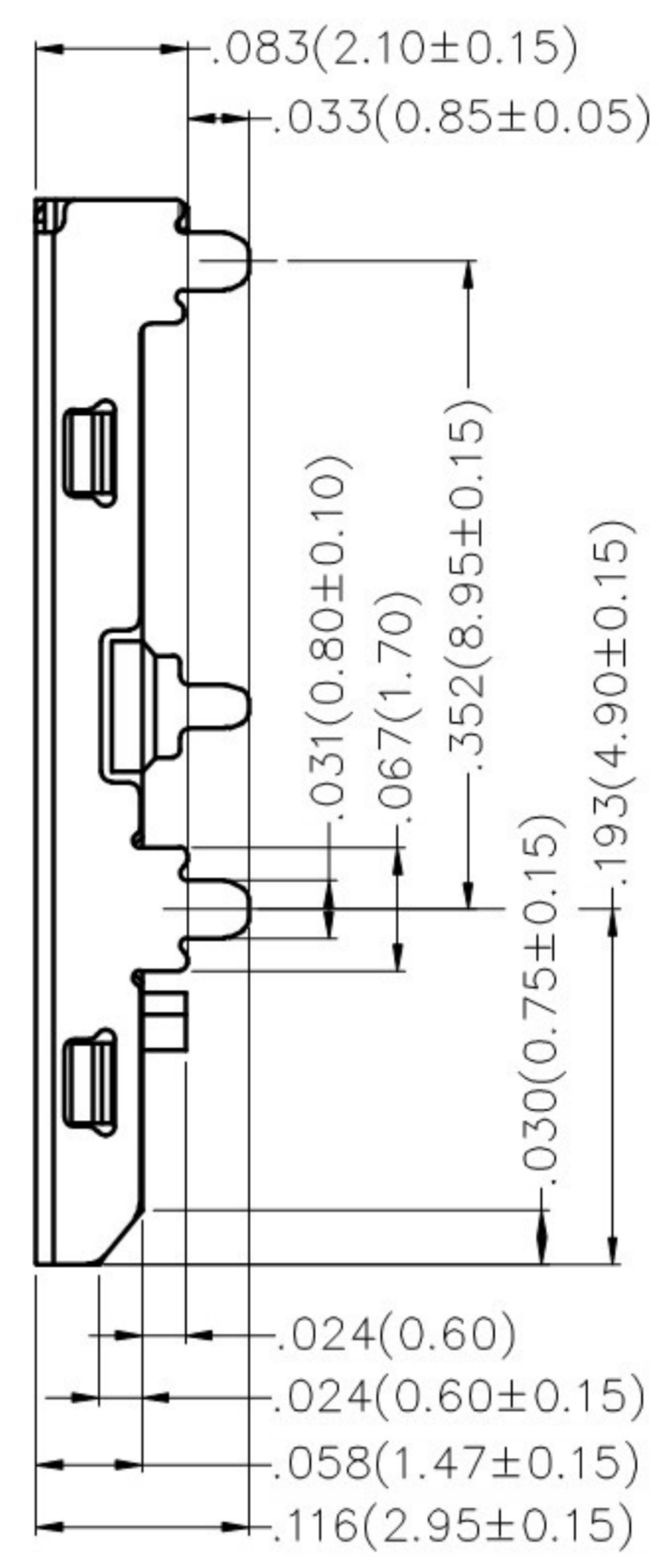
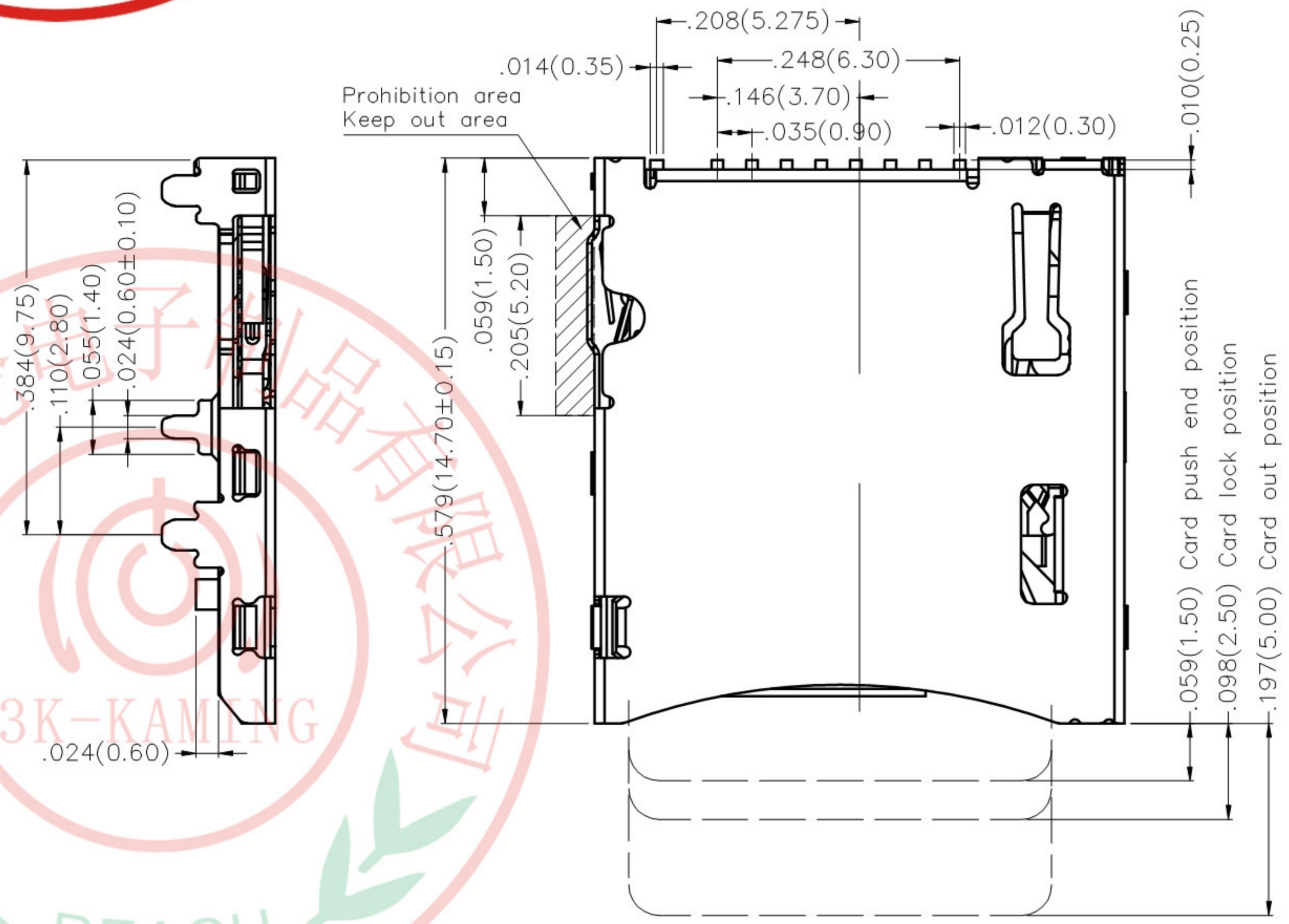
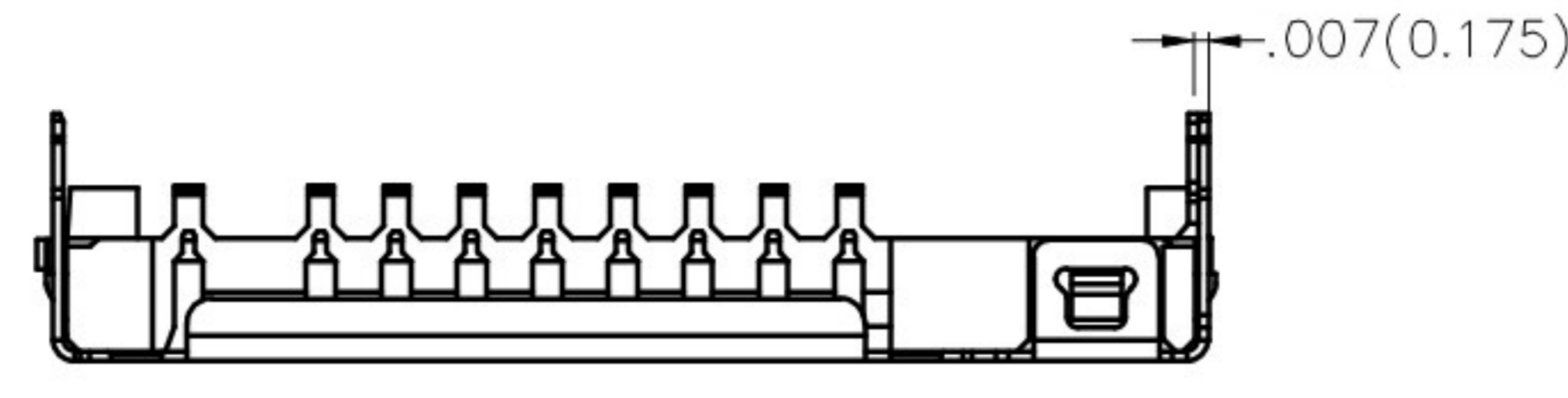

<p>THIRD ANGLE PROJECTION</p>	GENERAL TOLERANCES (UNLESS SPECIFIED)		APPROVE BY	DATE	PART NO.	ITEM NO.	<p>3K-KAMING</p>
	X.±.012(0.30)	X.±5'	FRANK	13/JUL/19	FCD423-7M	FCD423	
	X.X±.008(0.20)	.X'±2'	CHECKED BY	DATE	TITLE		
	X.XX±.006(0.15)	.XX'±1'	CHERRY	13/JUL/19	Micro sd card connector(H=2.1mm)		
SCALE	SIZE	X.XXX±.004(0.10)	.XXX'±0.5'	DRAWN BY	DATE	THIS DRAWING CONTAINS INFORMATION THAT IS PROPRIETARY TO DONG GUAN LANG LUN(3K-KAMING) ELECTRONIC PRODUCTS CO., LTD. AND SHOULD NOT BE USED WITHOUT WRITTEN PERMISSION	
5:1	A4			KATE	13/JUL/19	REV 0	SHEET NO. 1/3

1 2 3 4 5 6 7 8

REV	LOCATIONS	DESCRIPTION	DATE	REVISER	APPD



SPECIFICATIONS

Electrical

Current Rating: 0.5A AC(rms)/DC
Voltage Rating: 100V AC(rms)/DC
Contact Resistance: 100 mΩ Max
Insulation Resistance: 1000 MΩ Min/DC 250V
Withstanding Voltage: 500V AC r.m.s
Temperature Range-Operating: -25°C~+85°C

Material

Housing: LCP (UL 94V-0) Black
Contact: Copper alloy
Shell: Stainless steel

Plating

Contact: 1μ" gold in contact area, gold flash in solder area, Nickel plated overall
Shell: Gold flash in solder area, Nickel plated overall

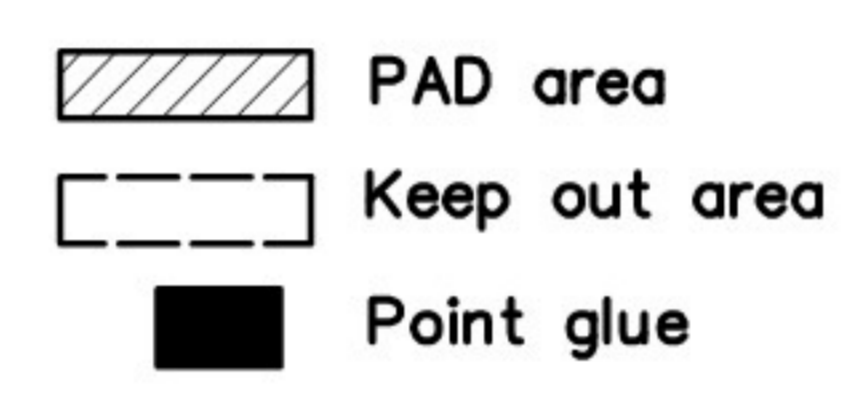
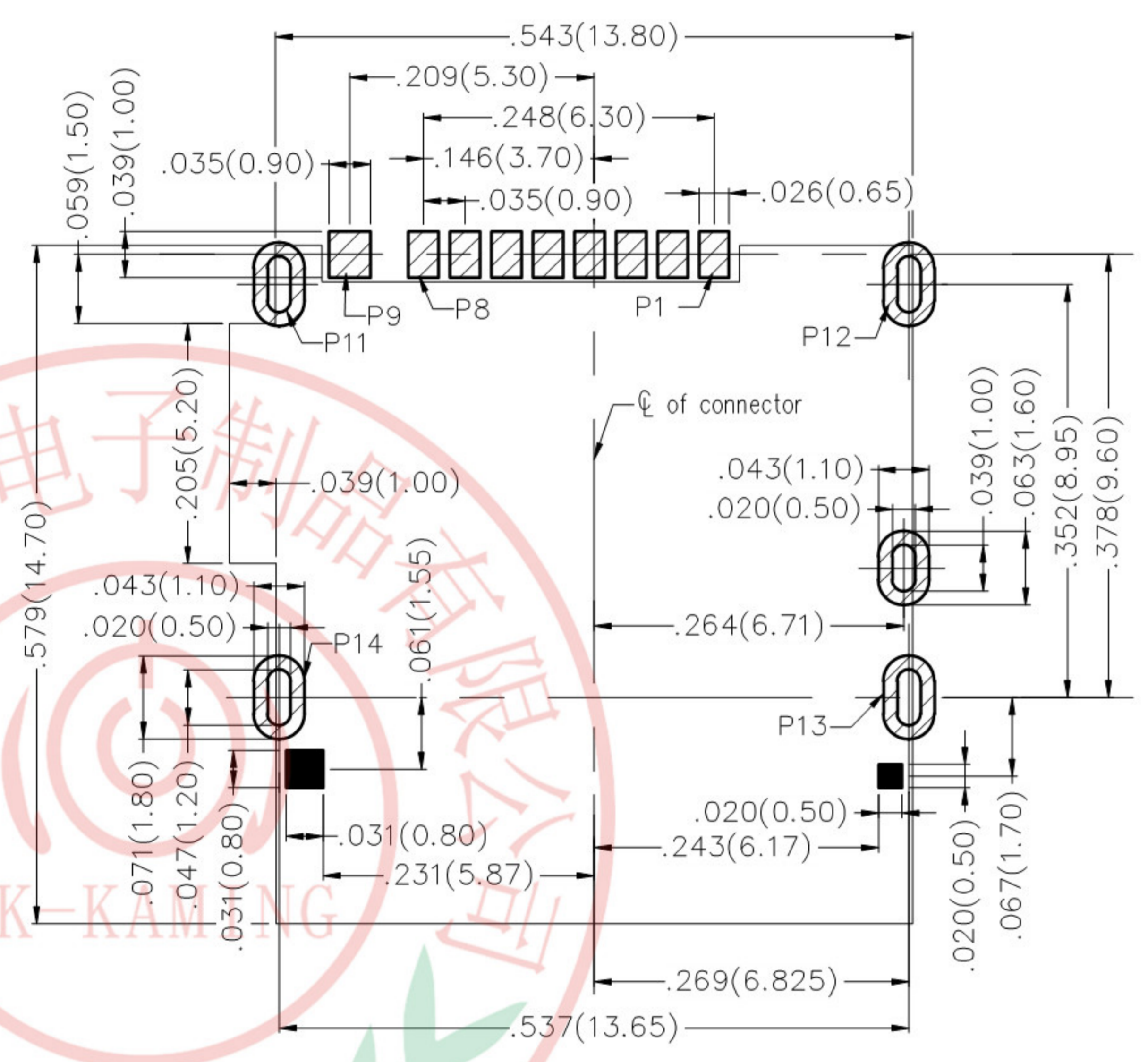

Recommended P.C.Board Layout
General tolerances: ±.002(0.05)

Pin No.	PIN ASSIGNMENT
P1	MICRO SD_DAT2
P2	MICRO SD_CD/DAT3
P3	MICRO SD_CMD
P4	MICRO SD_VDD
P5	MICRO SD_CLK
P6	MICRO SD_VSS
P7	MICRO SD_DAT0
P8	MICRO SD_DAT1
P9	MICRO SD_CD
P10	GND
P11	GND
P12	GND
P13	GND
P14	GND

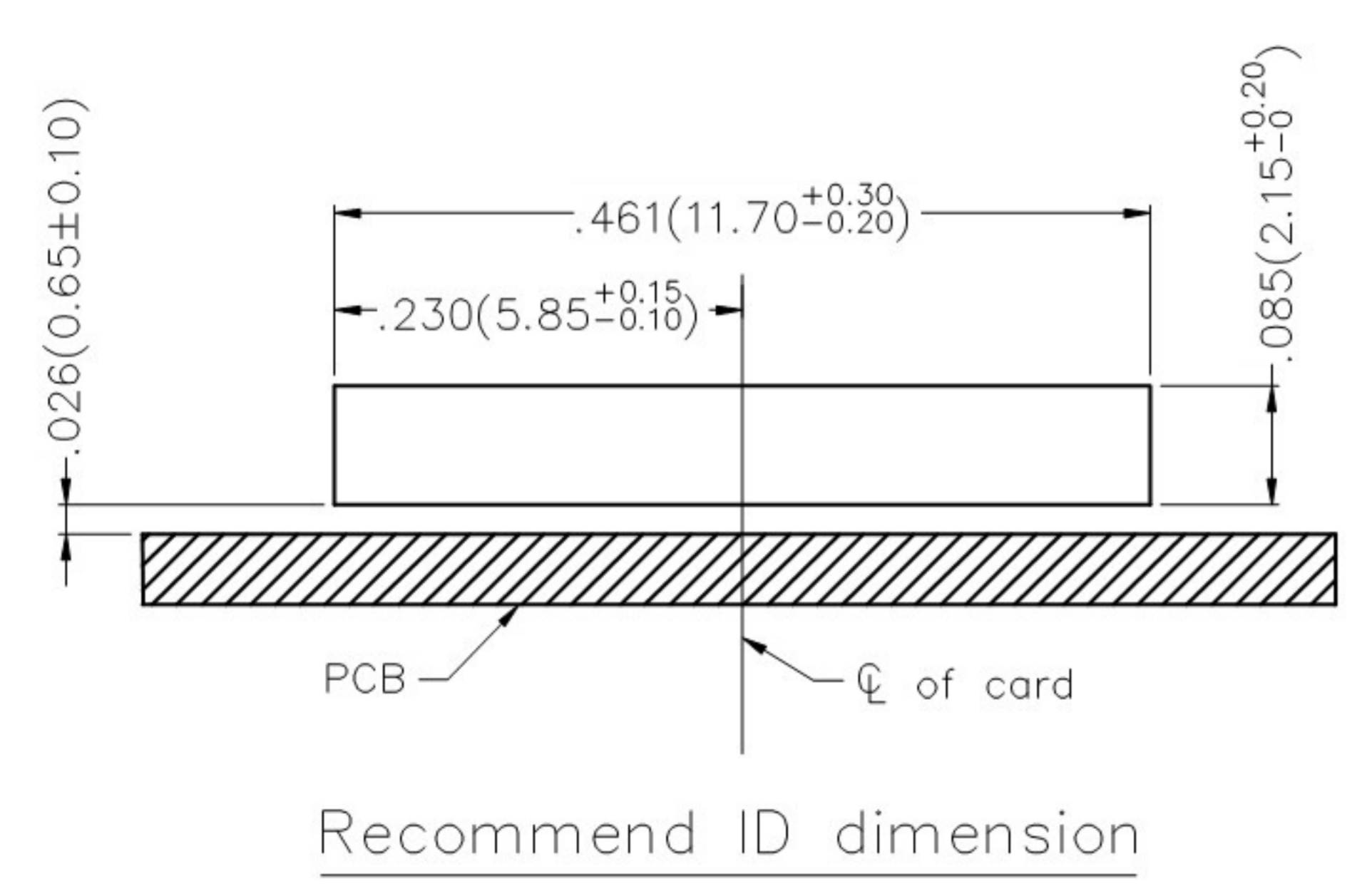
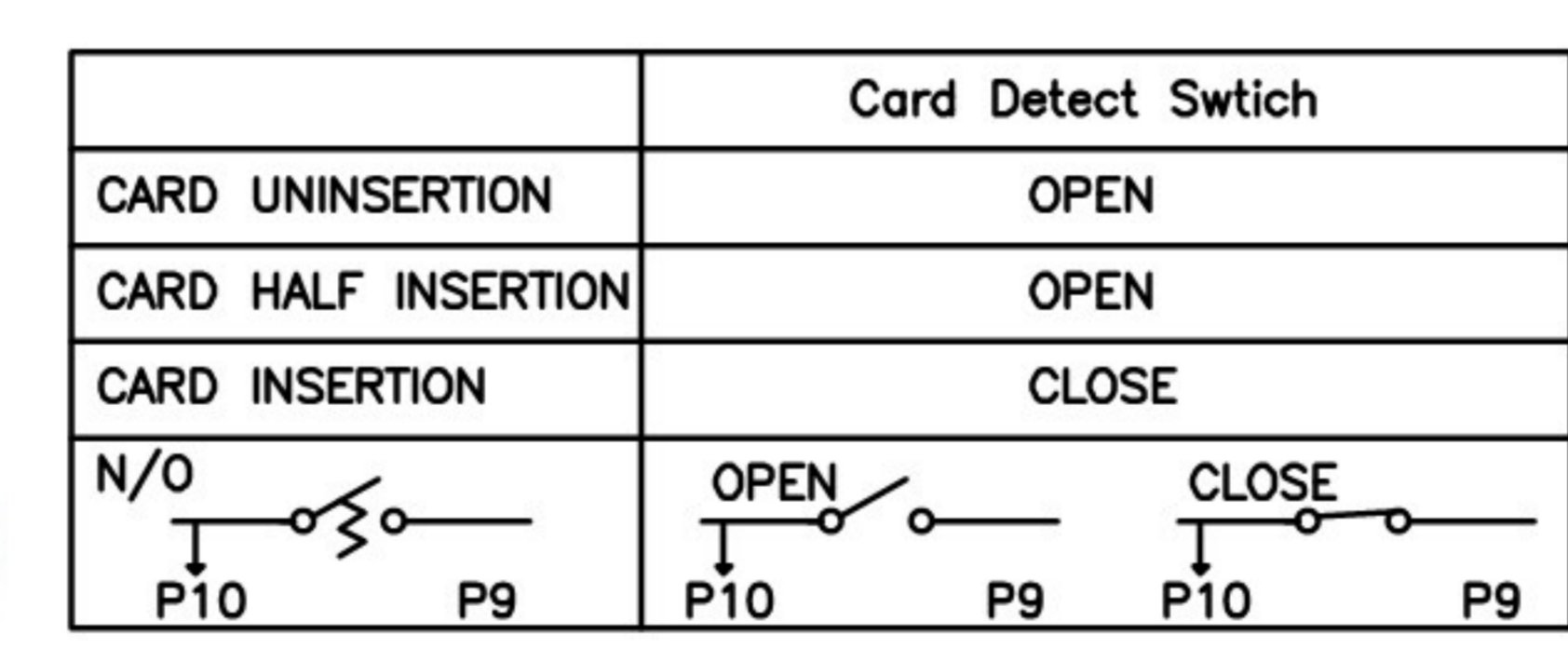

 THIRD ANGLE PROJECTION	GENERAL TOLERANCES (UNLESS SPECIFIED)		APPROVE BY FRANK	DATE 13/JUL/19	PART NO. FCD423-7M	ITEM NO. FCD423	 3K-KAMING		
	X.±.012(0.30)	X.±5'	CHECKED BY CHERRY	DATE 13/JUL/19	TITLE Micro sd card connector(H=2.1mm)			REV 0	SHEET NO. 2/3
	X.X±.008(0.20)	.X'±2'	DRAWN BY KATE	DATE 13/JUL/19	<small>THIS DRAWING CONTAINS INFORMATION THAT IS PROPRIETARY TO DONG GUAN LANG LUN(3K-KAMING) ELECTRONIC PRODUCTS CO.,LTD. AND SHOULD NOT BE USED WITHOUT WRITTEN PERMISSION</small>				
	X.XX±.006(0.15)	.XX'±1'							
SCALE 5:1	SIZE A4	X.XXX±.004(0.10)	.XXX'±0.5'						

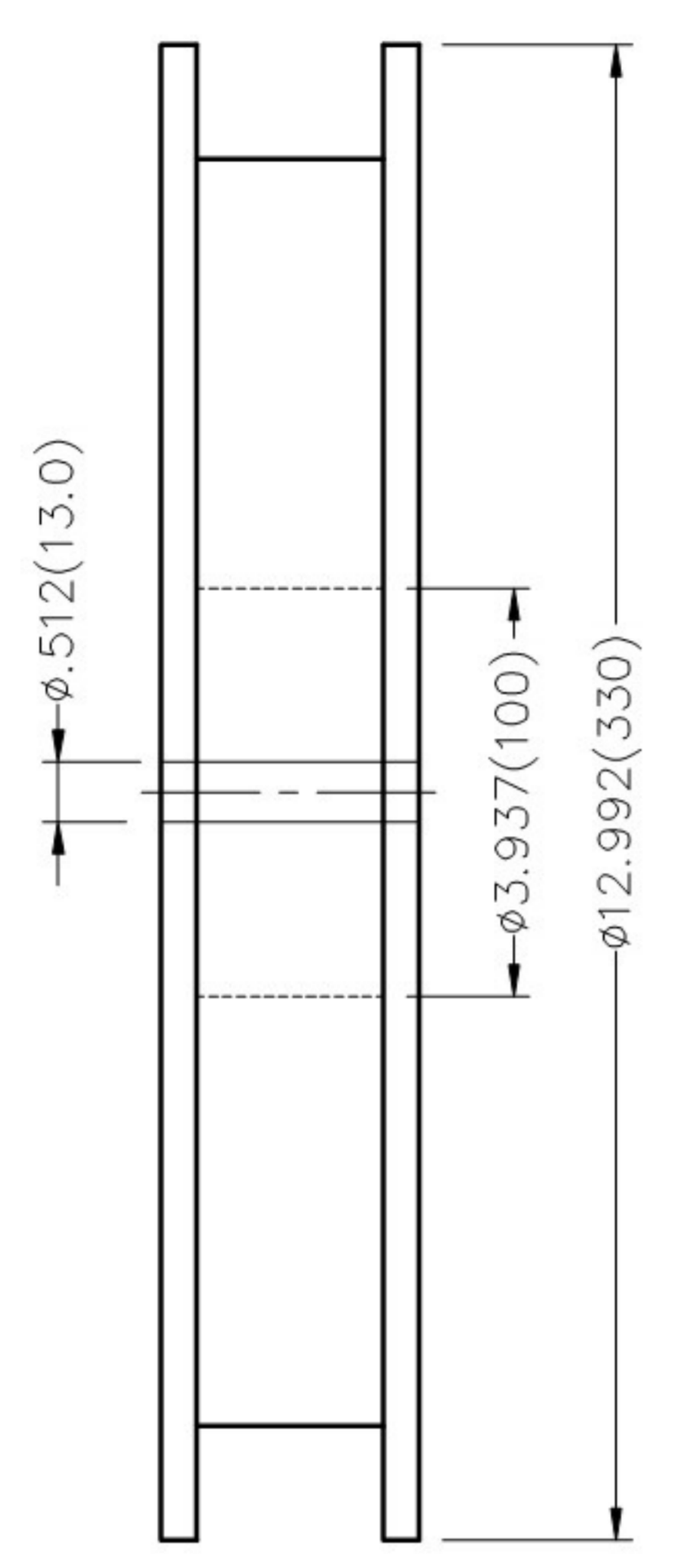
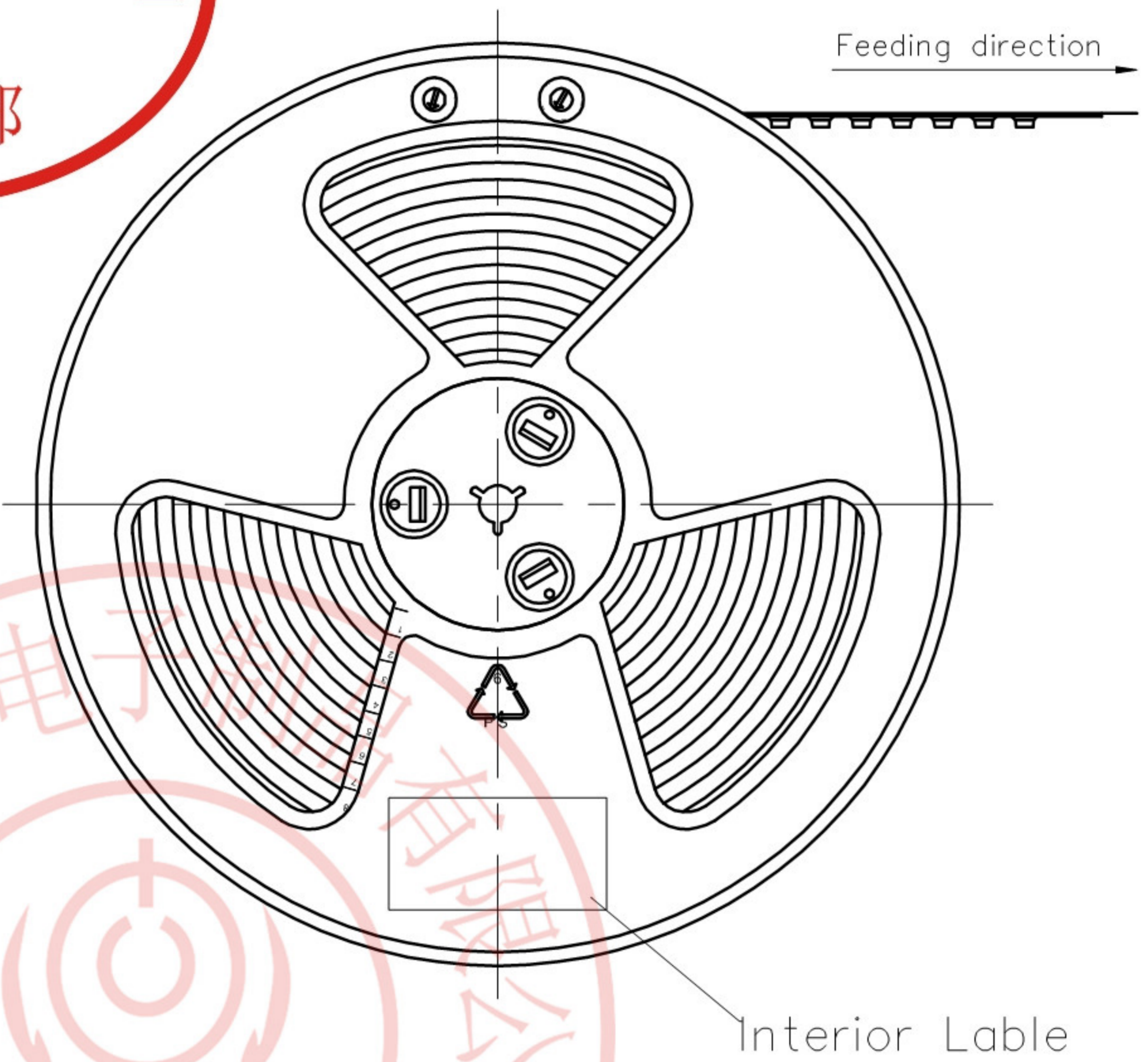

REV	LOCATIONS	DESCRIPTION	DATE	REVISER	APPD

- Note:
- 10 sprocket hole cumulative tolerance ± 0.2
 - Carrier camber is within 1.0mm in 100mm
 - Material: White Conductive polystyrene Alloy 100% recyclable
 - All dimensions meet EIA-481-3 requirements
 - Component load per 13" reel: 700 pcs

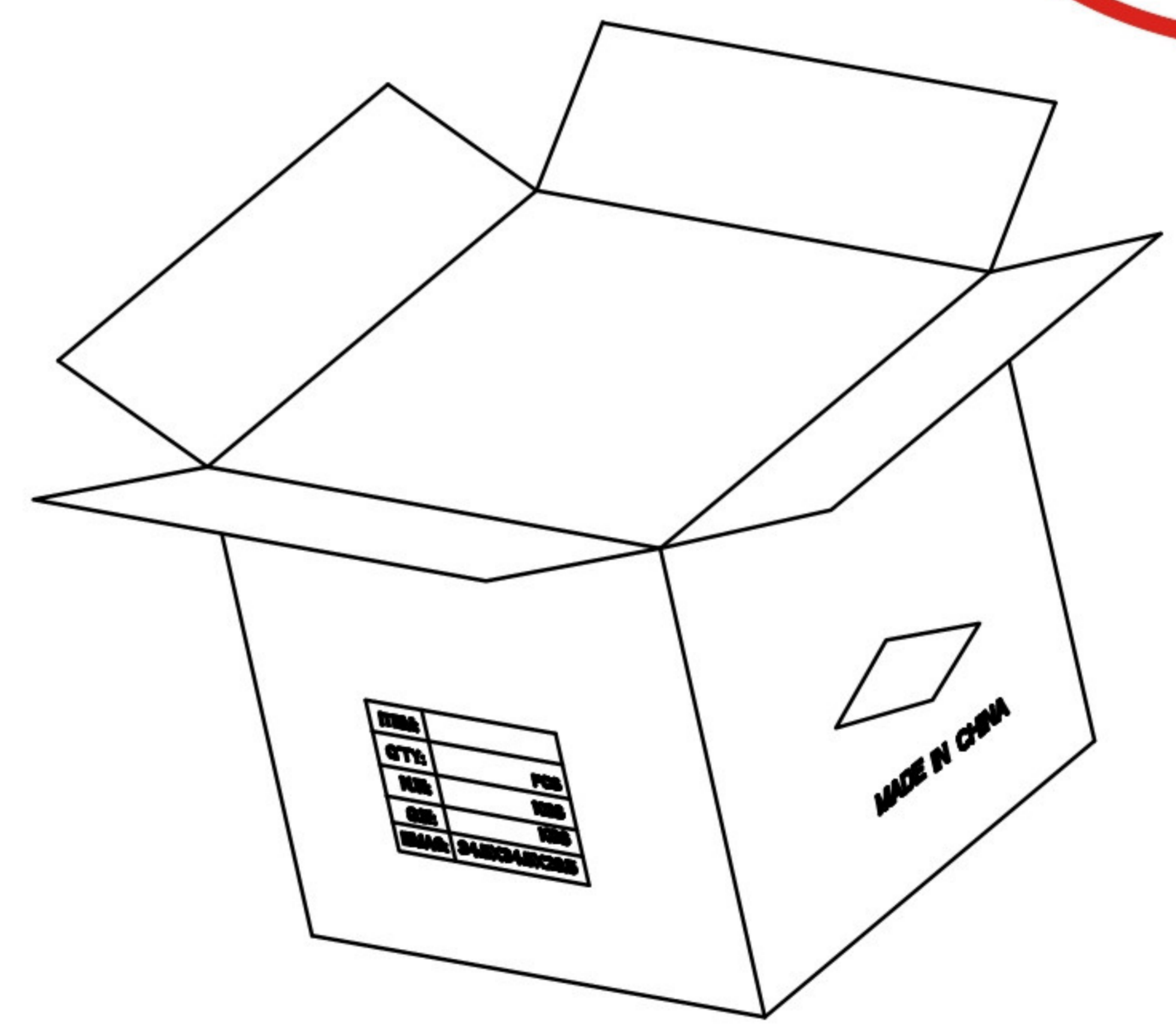
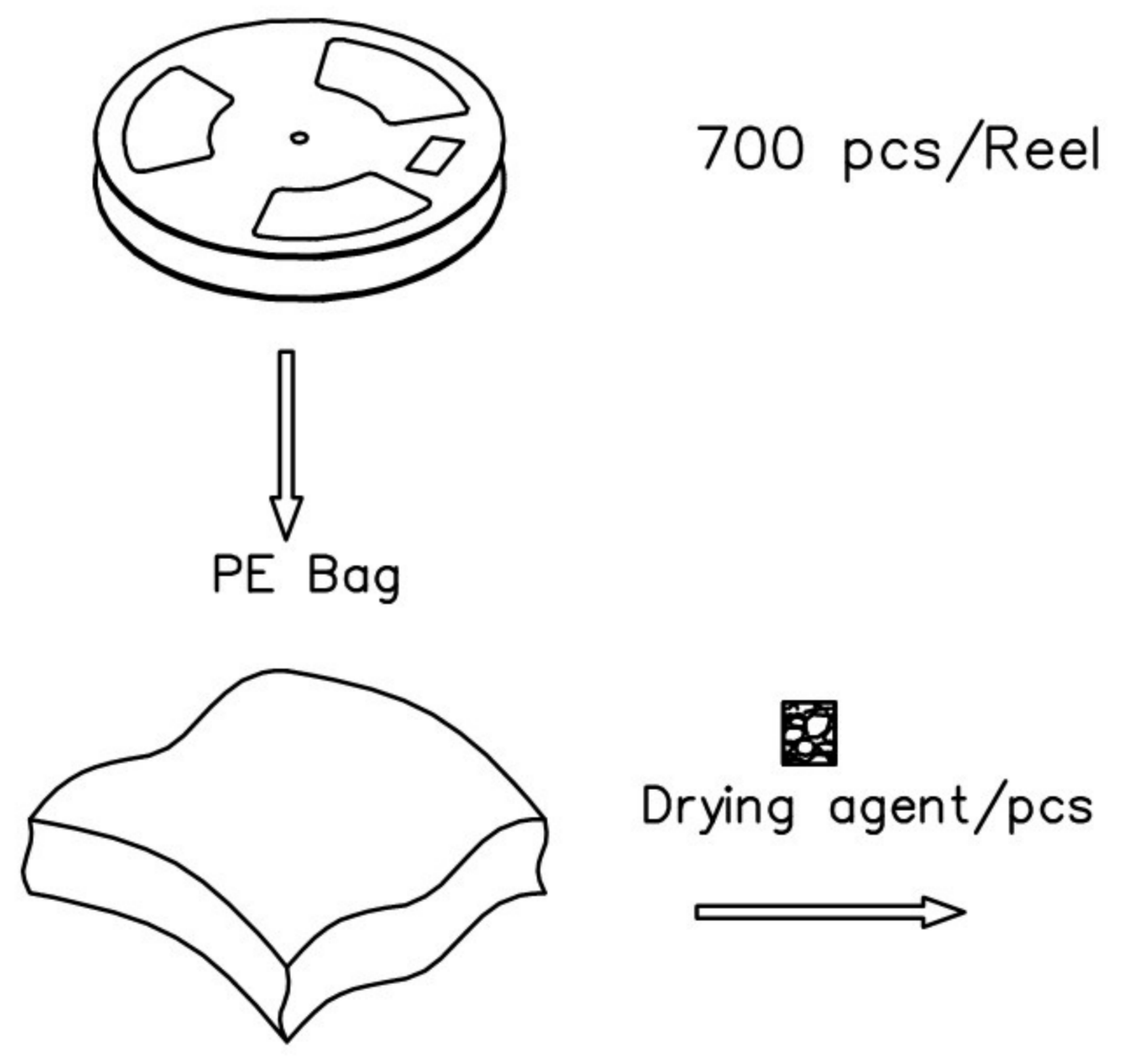
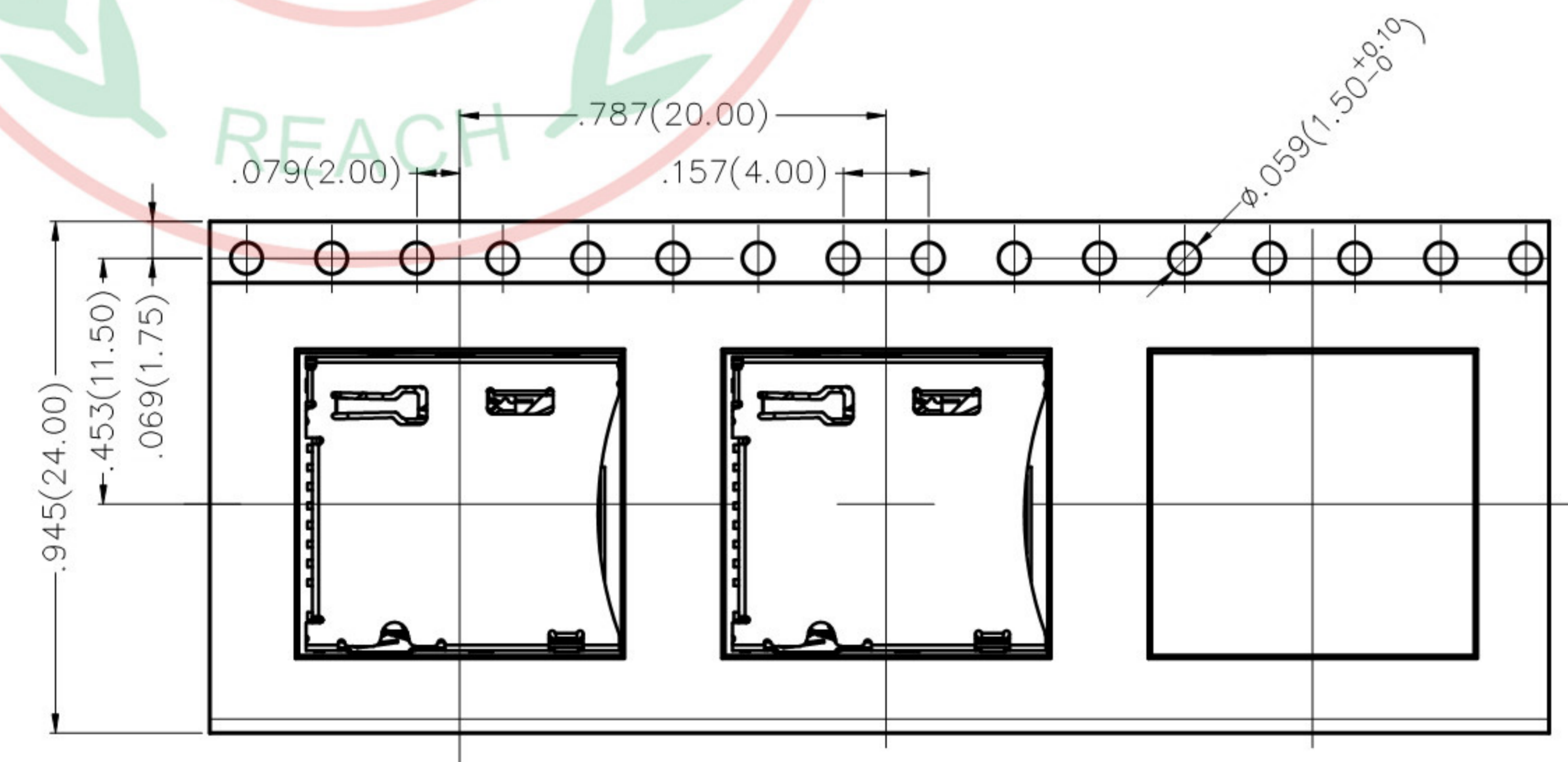
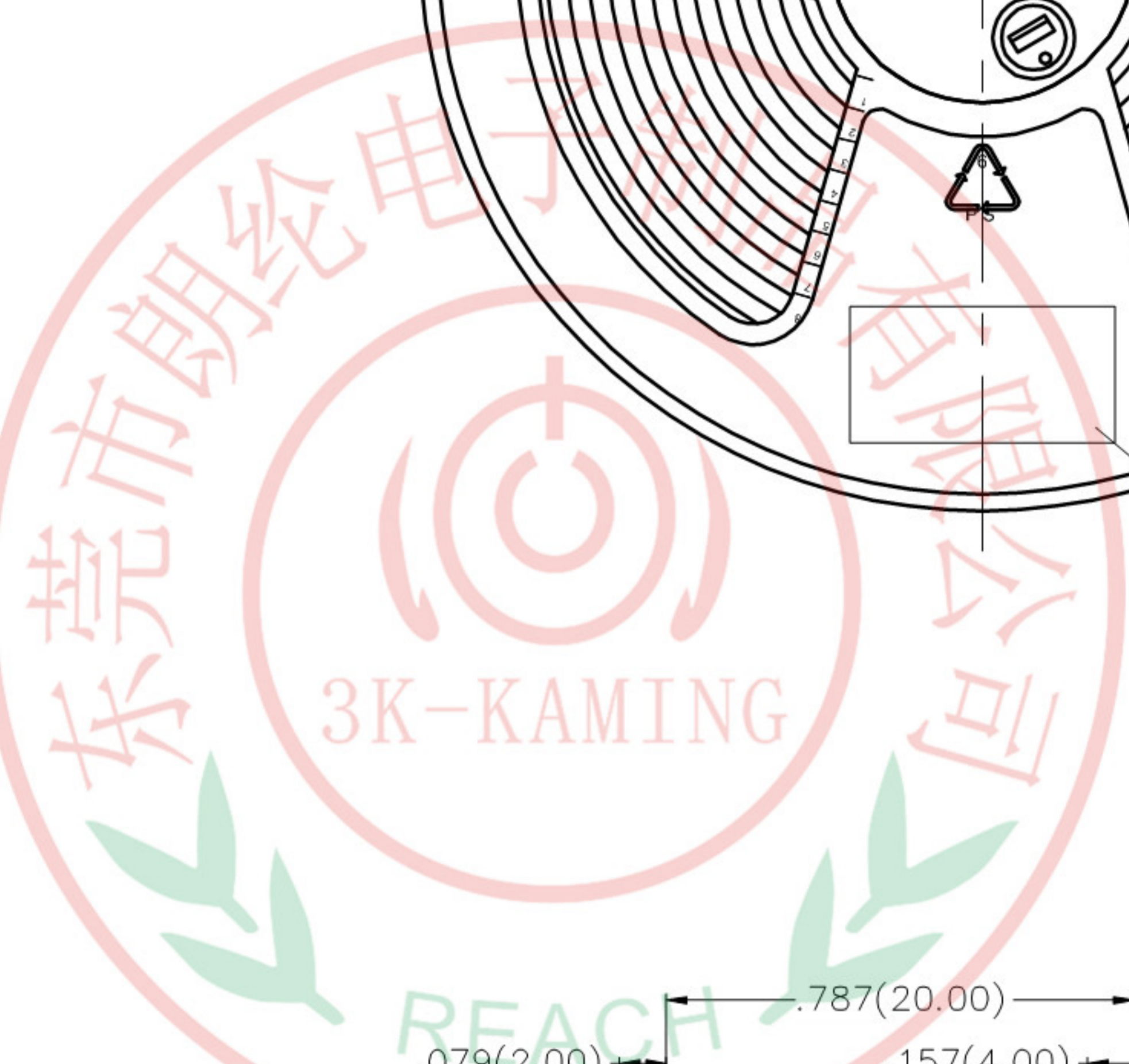
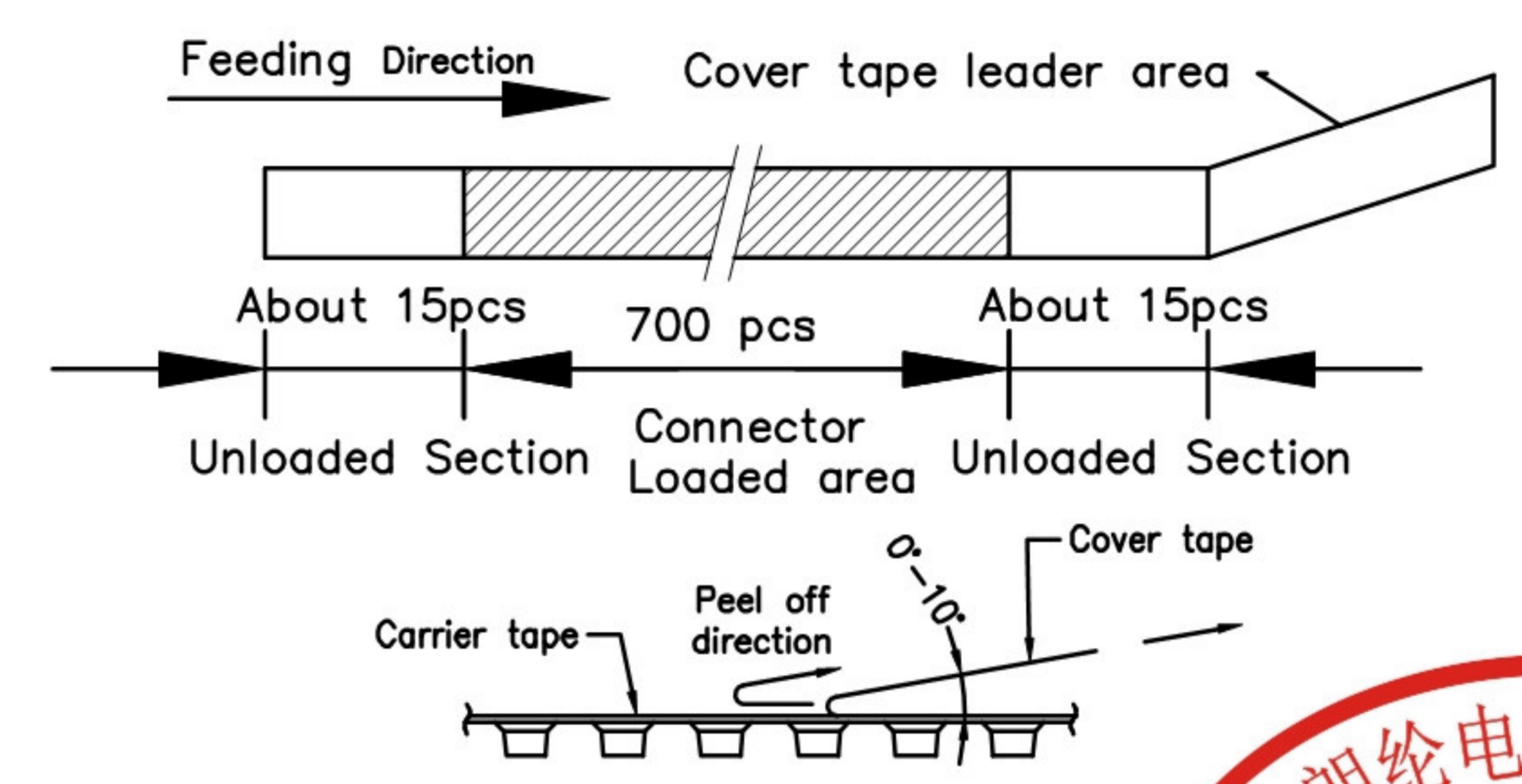

<p>THIRD ANGLE PROJECTION</p>	GENERAL TOLERANCES (UNLESS SPECIFIED)		APPROVE BY	DATE	PART NO.	ITEM NO.	<p>3K-KAMING</p>
	X. \pm .012(0.30)	X. \pm 5'	FRANK	13/JUL/19	FCD423-7M	FCD423	
	X.X \pm .008(0.20)	.X' \pm 2'	CHECKED BY	DATE	TITLE		
	X.XX \pm .006(0.15)	.XX' \pm 1'	CHERRY	13/JUL/19	Micro sd card connector(H=2.1mm)		
SCALE	SIZE	X.XXX \pm .004(0.10)	.XXX' \pm 0.5'	DRAWN BY	DATE	THIS DRAWING CONTAINS INFORMATION THAT IS PROPRIETARY TO DONG GUAN LANG LUN(3K-KAMING) ELECTRONIC PRODUCTS CO., LTD. AND SHOULD NOT BE USED WITHOUT WRITTEN PERMISSION	
5:1	A4			KATE	13/JUL/19	REV 0	SHEET NO. 3/3