

REV	LOCATIONS	DESCRIPTION	DATE	REVISER	APPD

**SPECIFICATIONS**

**Electrical**  
 Current Rating: 0.5A AC(rms)/DC  
 Voltage Rating: 100V AC(rms)/DC  
 Contact Resistance: 100 mΩ Max  
 Insulation Resistance: 1000 MΩ Min  
 Withstanding Voltage: 500V AC r.m.s  
 Temperature Range—Operating: -25°C~+85°C  
 Durability: 5,000 Cycles

**Material and Plating**  
 Housing: Thermoplastic (UL 94V-0) Black  
 Terminal: Phosphor Bronze/ Gold plated on contact area,  
 Matte tin 100u" Min on solder area, 50u" Min nickel plating overall  
 Shell: Stainless Steel SUS304/ 30u" Min Nickel plated overall,  
 Au 1u" Min on solder area.

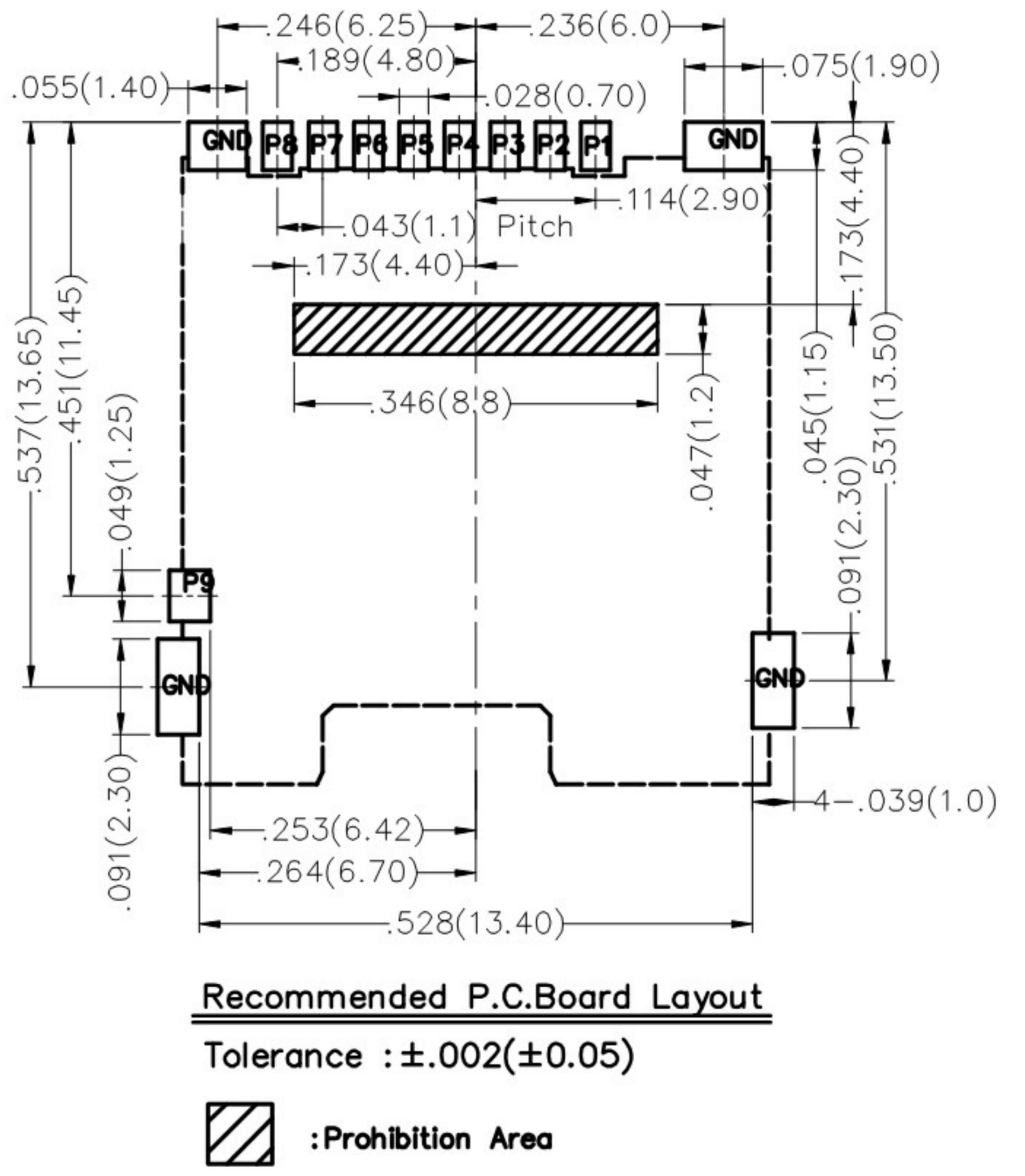
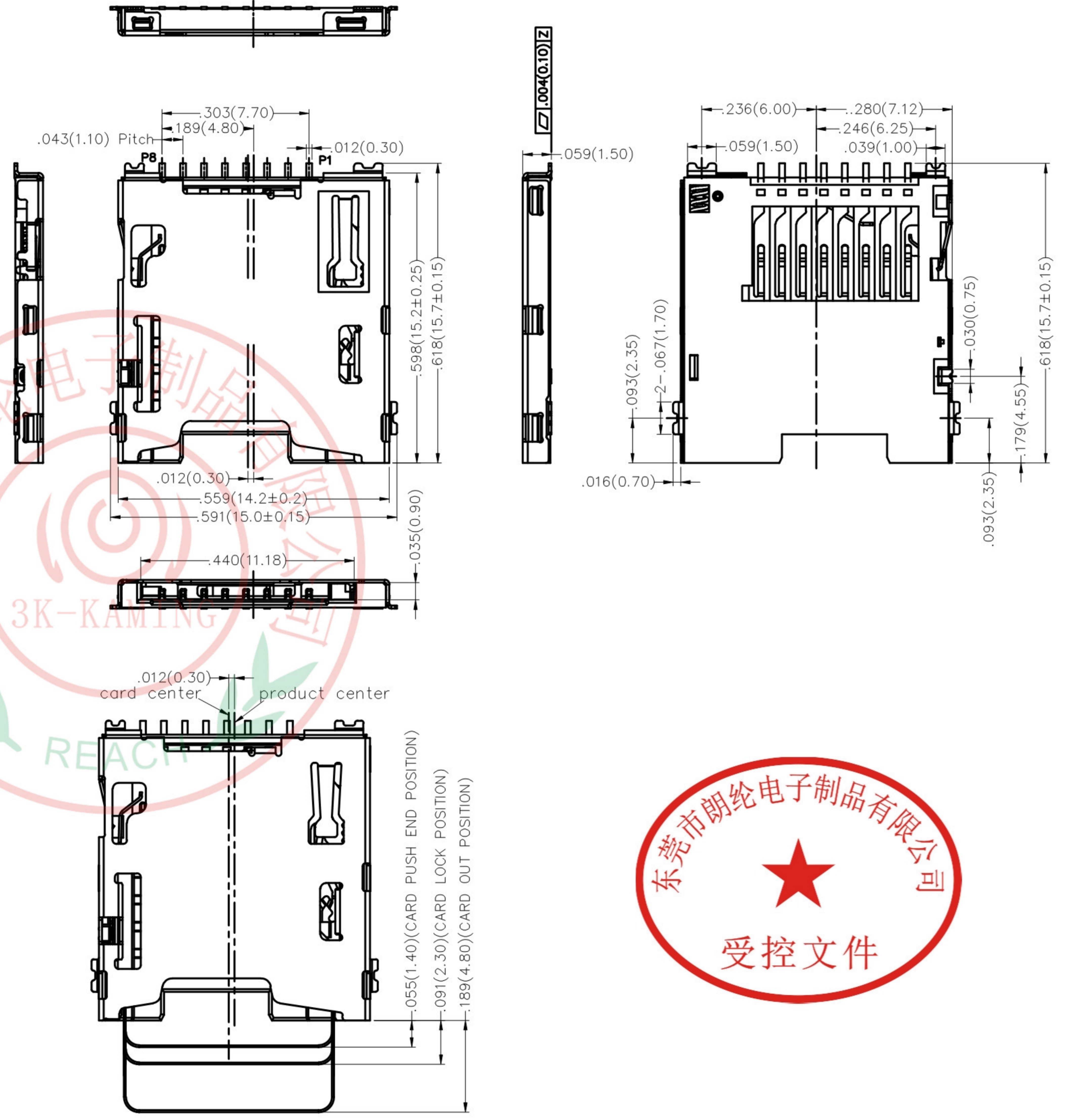

PIN NO.	discription
Pin 1	DAT2:Data line
Pin 2	CD/DAT3:card Detect/Data line
Pin 3	CMD:command/Response
Pin 4	VDD: Supply voltage
Pin 5	CLK:Clock
Pin 6	VSS:Supply voltage ground
Pin 7	DAT0:Data line
Pin 8	DAT1:Data line
Pin 9	DETECT SW(GND)
GND	Cover GND

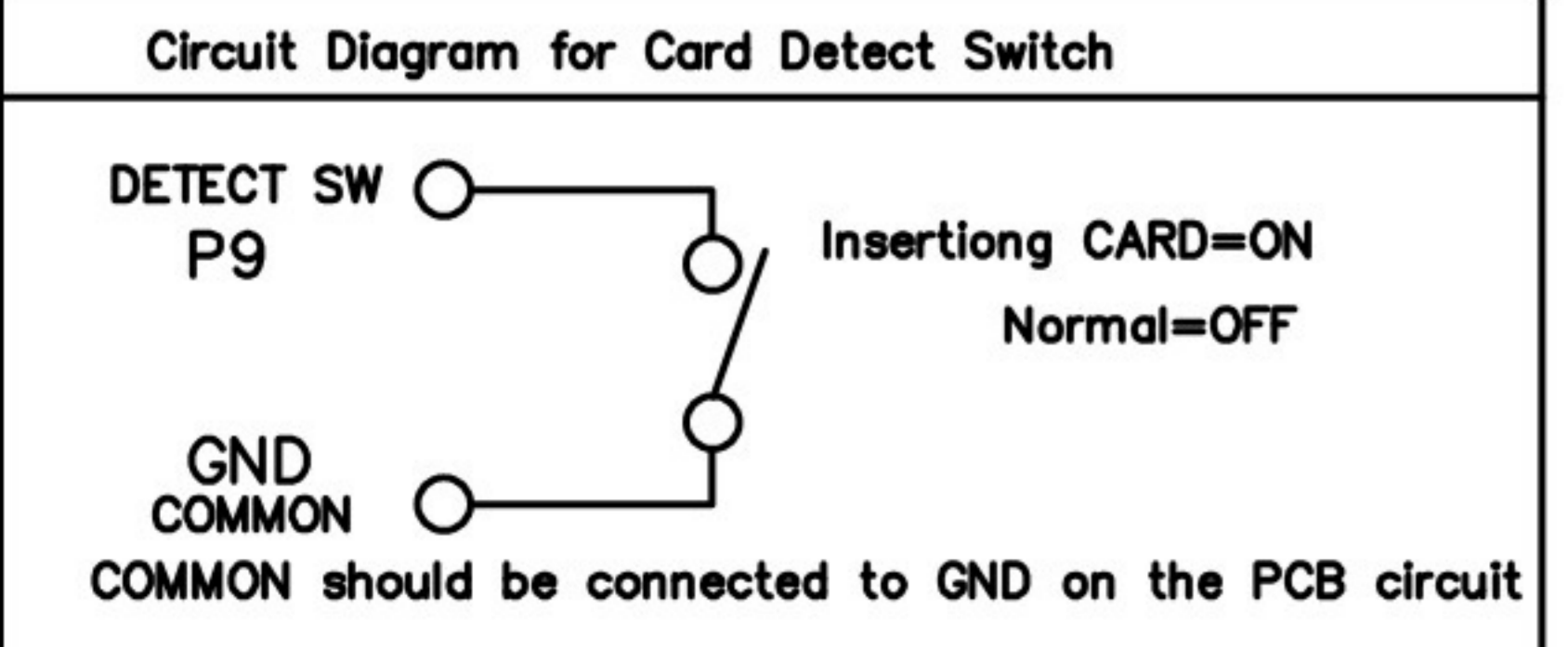

 THIRD ANGLE PROJECTION DESIGN UNITS Inch (metric) SCALE 5:1 SIZE A4	GENERAL TOLERANCES (UNLESS SPECIFIED)		APPROVE BY FRANK	DATE 18/JUN/17	PART NO. FCD428-7M	ITEM NO. FCD428	 3K-KAMING REV 0 SHEET NO. 1/2 THIS DRAWING CONTAINS INFORMATION THAT IS PROPRIETARY TO DONG GUAN LANG LUN(3K-KAMING) ELECTRONIC PRODUCTS CO.,LTD. AND SHOULD NOT BE USED WITHOUT WRITTEN PERMISSION
	X.±.012(0.30)	X.±5'	CHECKED BY CHERRY	DATE 18/JUN/17	TITLE Mirco SD card connector(H:1.50mm) (Push to Push)		
	X.XX±.008(0.20)	.X'±2'	DRAWN BY KATE	DATE 18/JUN/17			
	X.XX±.006(0.15)	.XX'±1'					
	X.XXX±.004(0.10)	.XXX'±0.5'					

REV	LOCATIONS	DESCRIPTION	DATE	REVISER	APPD

**Note:**

1. 10 sprocket hole cumulative tolerance  $\pm 0.008(0.2)$
2. Carrier camber is within 1.0mm in 100mm
3. Material: White Conductive polystyrene Alloy 100% recyclable
4. All dimensions meet EIA-481-3 requirements
5. Component load per 13" reel: 1,200pcs

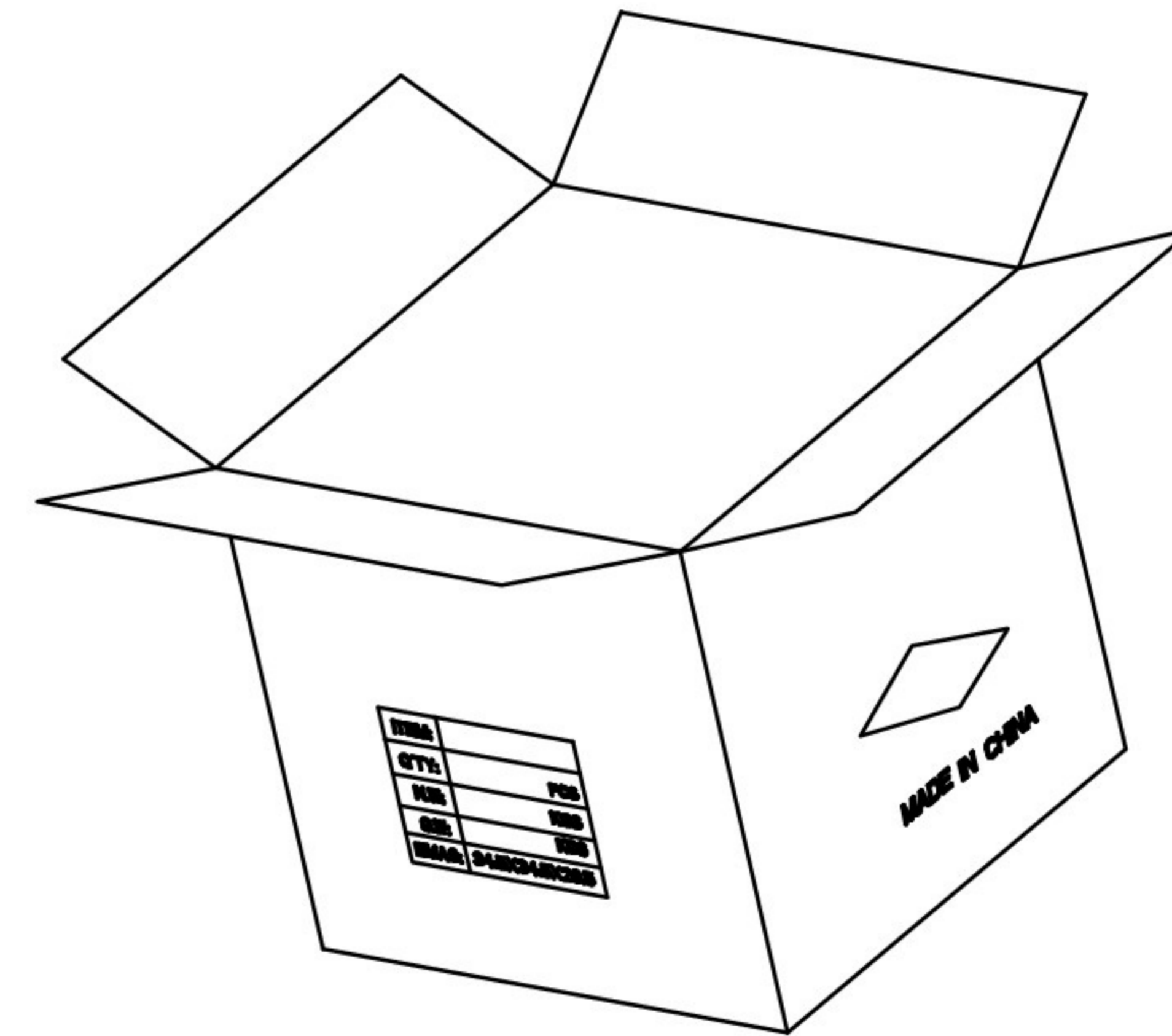
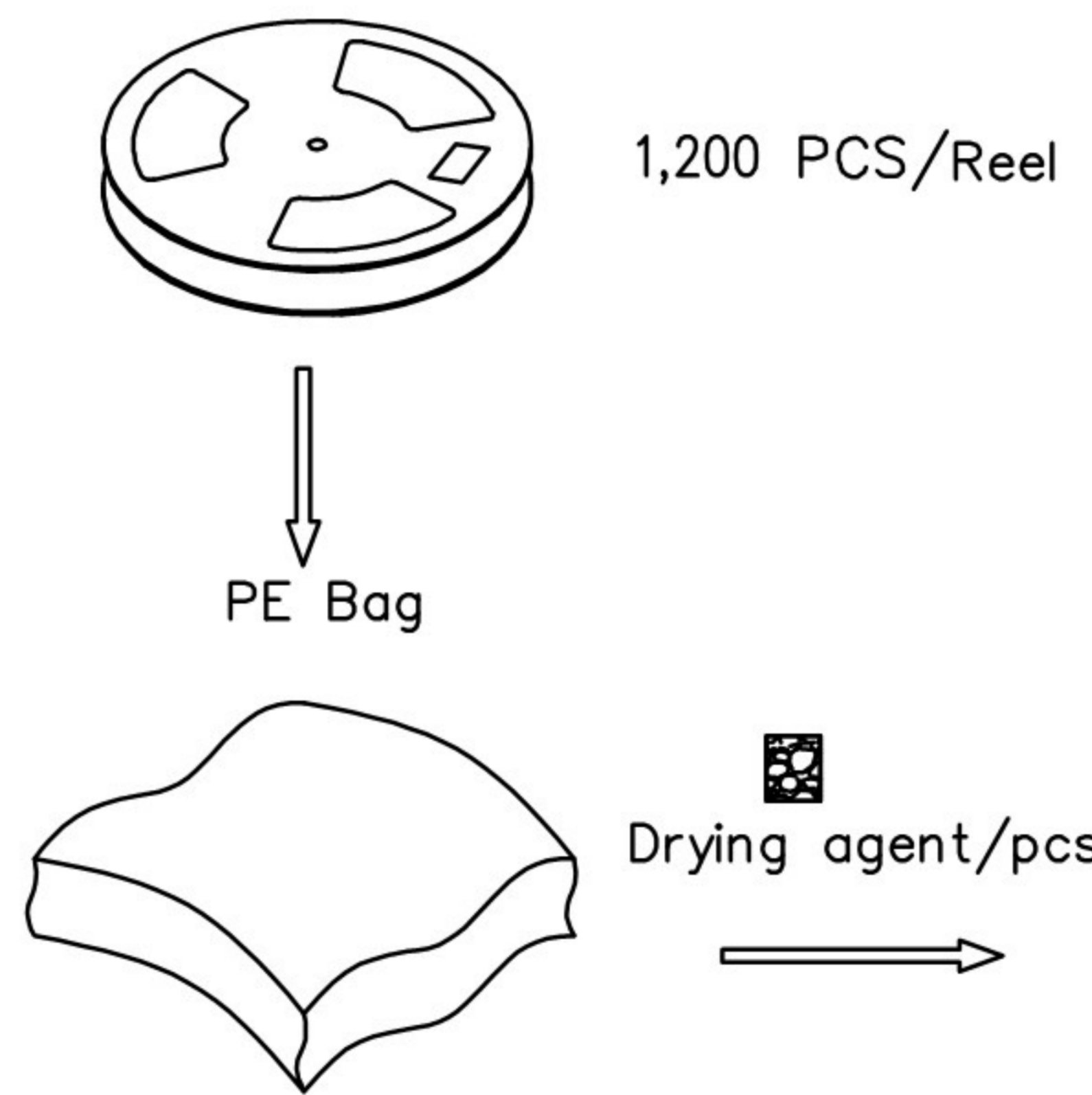
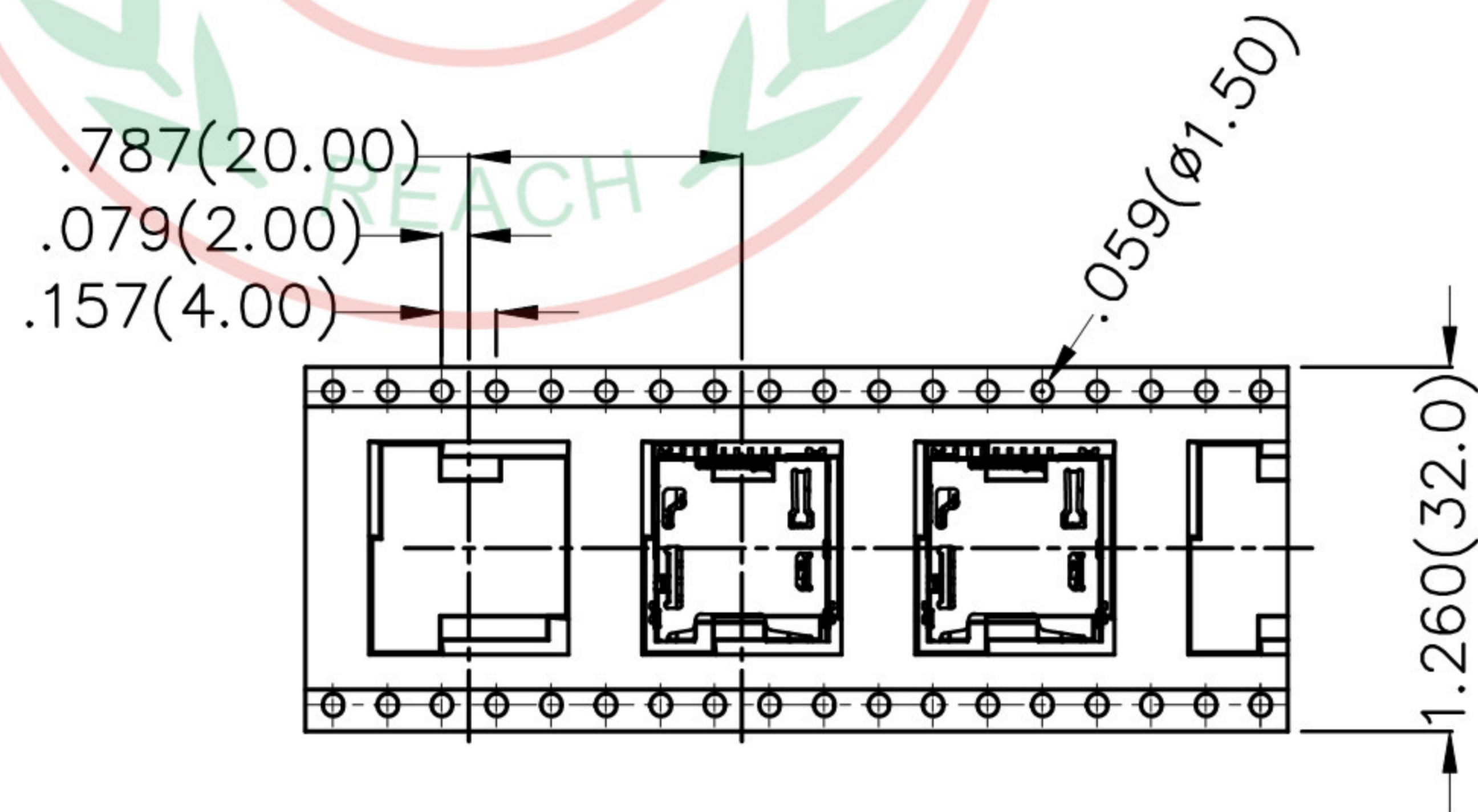
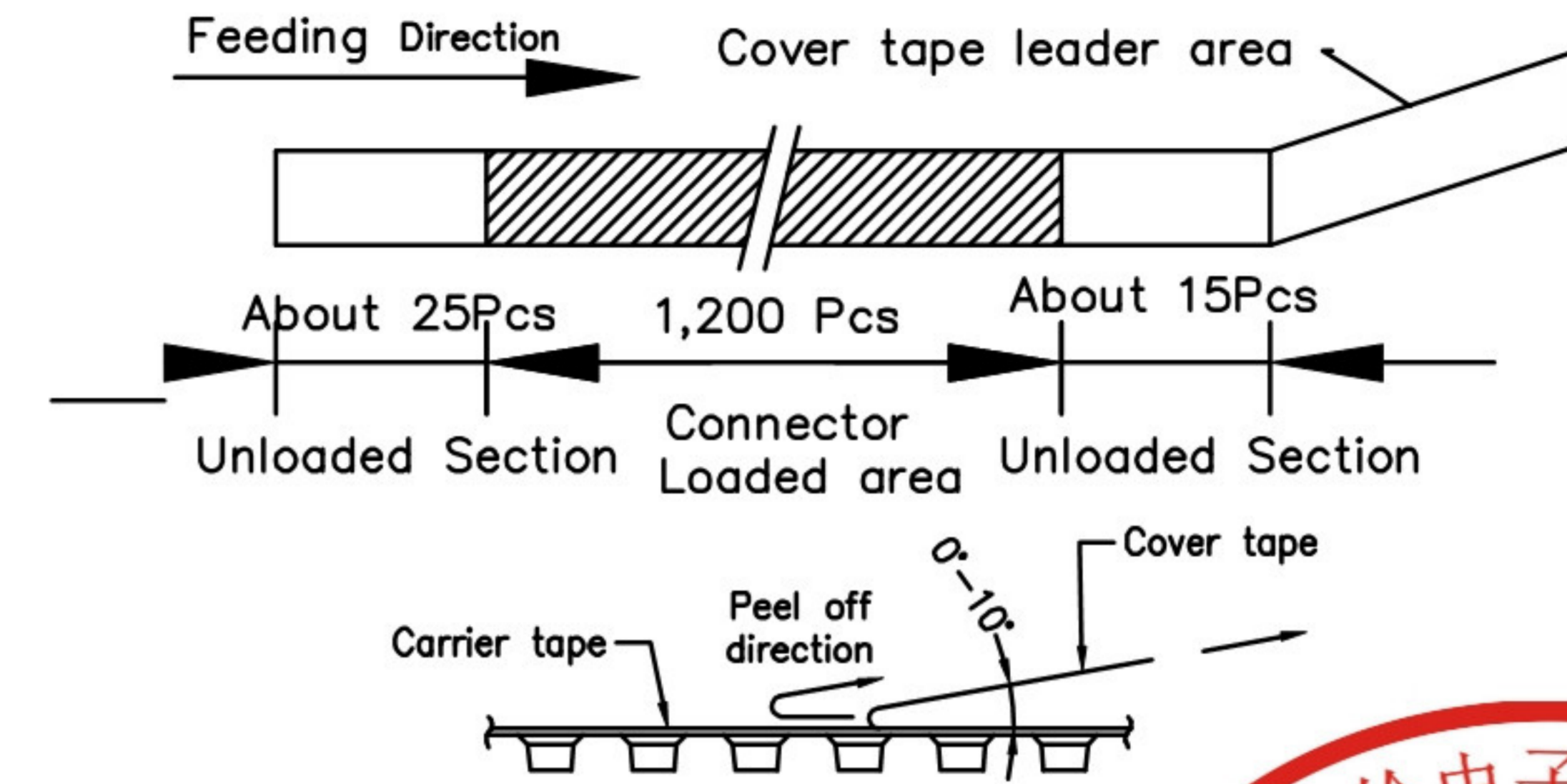
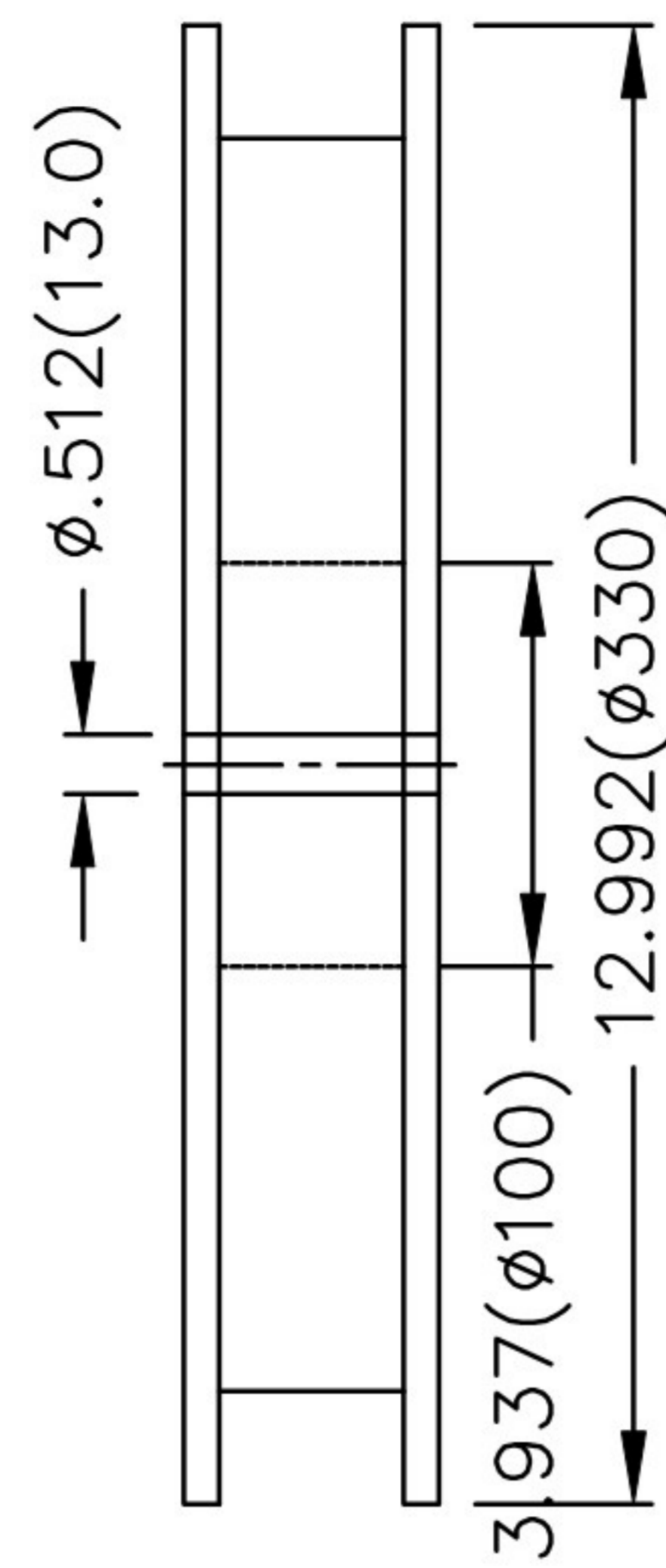
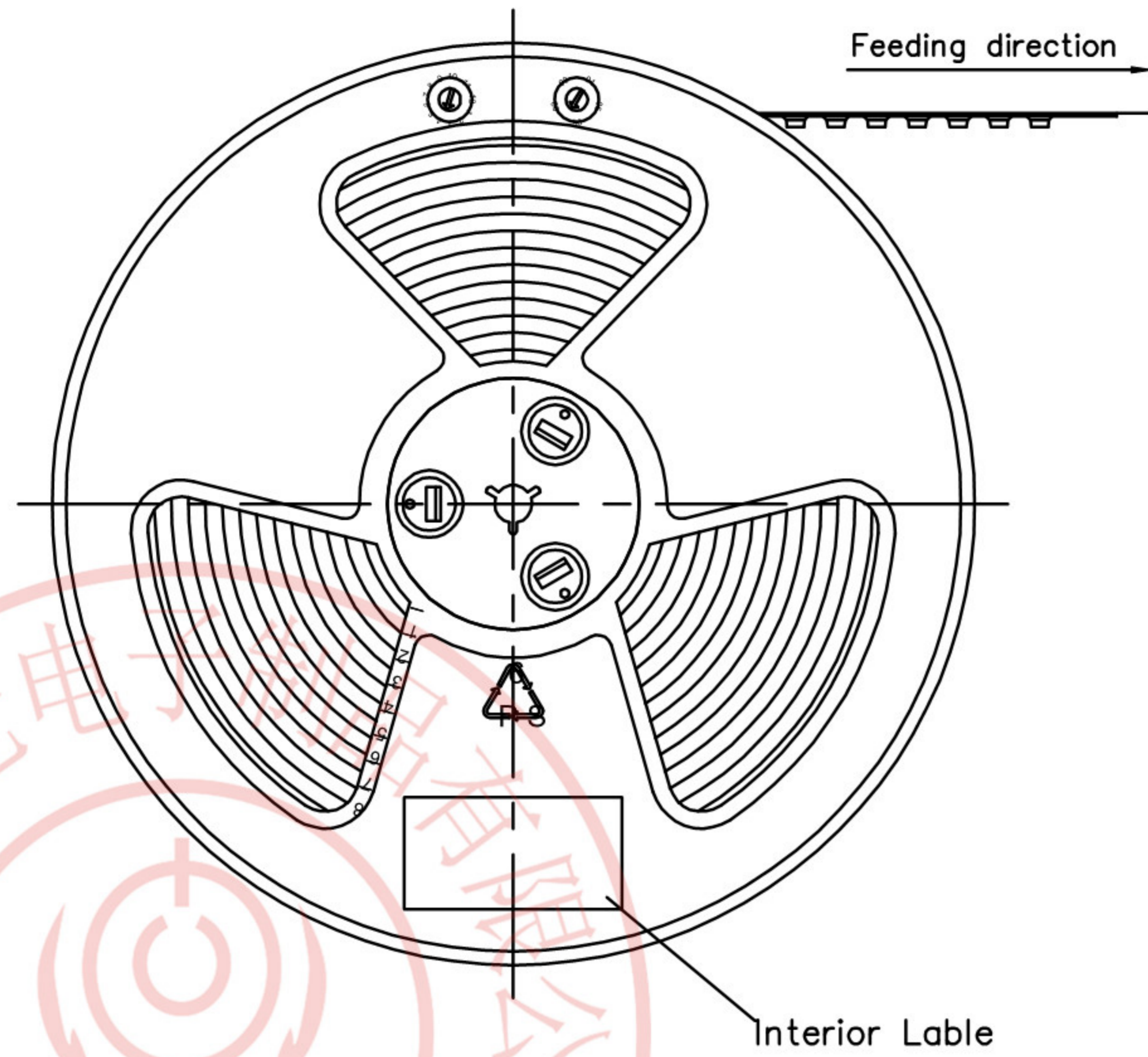

<p>THIRD ANGLE PROJECTION</p>	GENERAL TOLERANCES (UNLESS SPECIFIED)		APPROVE BY	DATE	PART NO.	ITEM NO.	<p>3K-KAMING</p>
	X.±.012(0.30)	X.±5'	FRANK	31/JUL/13	FCD428-7M	FCD428	
	X.X±.008(0.20)	.X'±2'	CHECKED BY	DATE	TITLE		
	X.XX±.006(0.15)	.XX'±1'	CHERRY	31/JUL/13	Mirco SD card connector(H:1.5mm) (Push to Push)		
SCALE	SIZE	X.XXX±.004(0.10)	.XXX'±0.5'	DRAWN BY	DATE	THIS DRAWING CONTAINS INFORMATION THAT IS PROPRIETARY TO DONG GUAN LANG LUN(3K-KAMING) ELECTRONIC PRODUCTS CO.,LTD. AND SHOULD NOT BE USED WITHOUT WRITTEN PERMISSION	
5:1	A4			JACOB	31/JUL/13	REV 0	SHEET NO. 2/2