

序号	品名	材质
①	0.5后压卧式胶芯 (H1.5)	LCP UL94V-0 本色
②	0.5后压卧式端子 (H1.5)	磷青铜/表面镀锡 镀金
③	0.5后压卧式1代后盖 (H1.2)	LCP UL94V-0 黑色
④	0.5后压卧式焊片 (H1.5)	磷青铜/表面镀锡

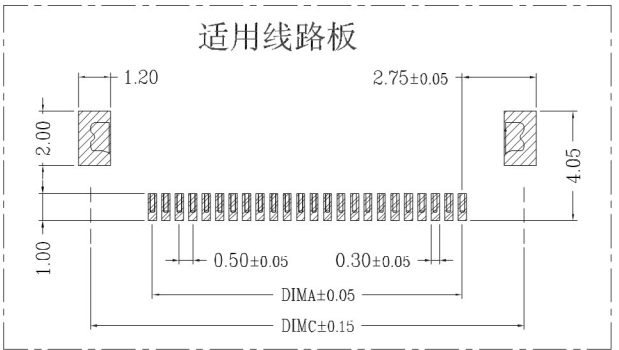
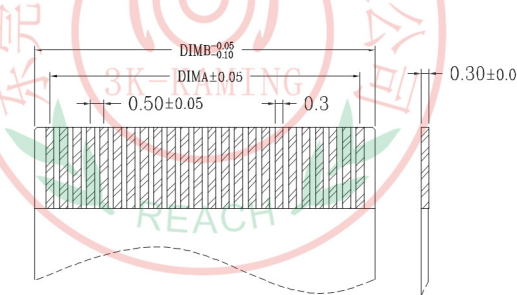
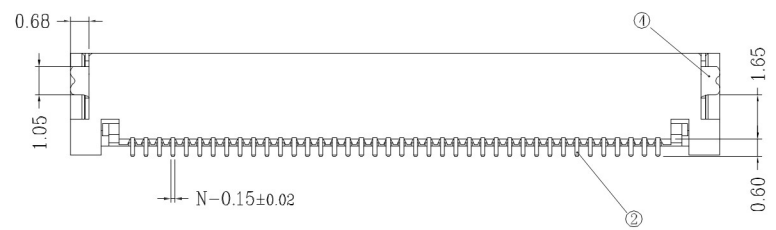
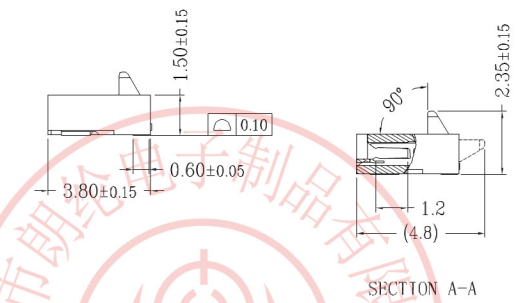
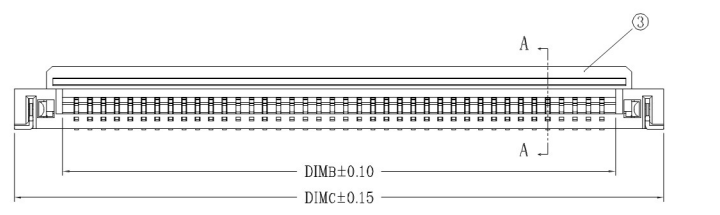
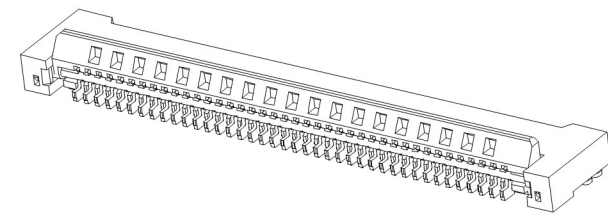
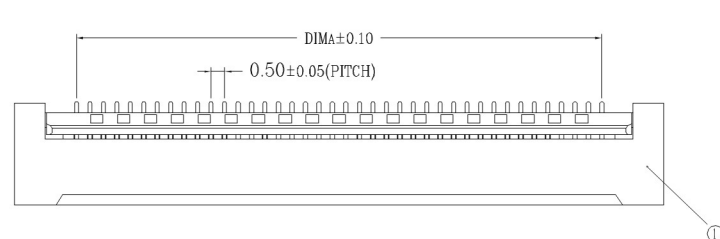

适用扁平线

技术指标:

1. 塑件表面应光洁、无毛边、无明显收缩、缺陷、裂纹等现象。
2. 温度范围: -25° C~85° C.
3. 额定电压: 50V, AC/DC(等效).
4. 接触电阻: ≤0.03Ω.
5. 绝缘电阻: ≥500MΩ

UNITS mm	东莞市朗纶电子制品有限公司 Dongguan langlun electronic products Co., Ltd		
MAT'L	PART NO.(INTENDED USE) 0515-GX-nPWB	TITLE: 0.5前插后掀盖H1.5	
FINISH	APPD:	DWG NO.: 0515-GX-nPWB	
Q'TY PCS	CHKD:	DR: HU 2016.09.28	SCALE 1/1
			SHEET 1/1
			REV. A

X.± 0.3	X. ^o ± 5°
.X± 0.25	.X. ^o ± 2°
.XX± 0.20	.XX. ^o ± 1°
.XXX± 0.10	.XXX. ^o ± 0.5°