

ALLOWANCE	
UNDER 3	± 0.1
3 TO 6	± 0.15
6 TO 15	± 0.2
15 TO 50	± 0.25
50 OVER	± 0.3

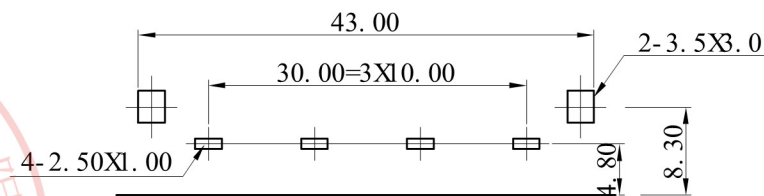

PCB LAYOUT

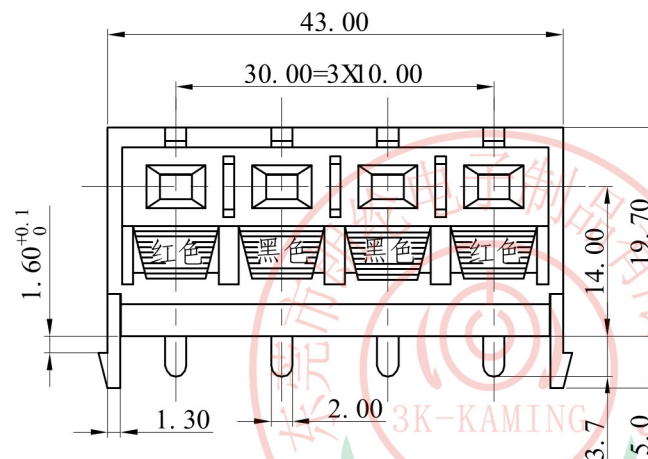
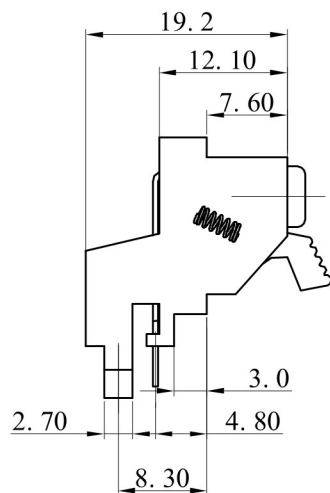

MODEL NO : WP4-19	ALLOWANCE:	DRAWN BY:
TYPE : WP PUSH TERMINAL	UNIT: mm	CHECKED BY:
MATERIAL NO :	SCALE:	APPROVED BY:
PROJECTION 		东莞市朗纶电子制品有限公司 Dongguan langlun electronic products Co., Ltd