

PANEL CUT OUT

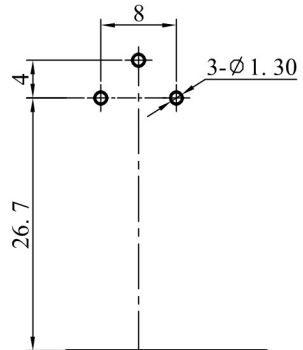

PCB LAYOUT



MODEL NO :SPF-02B	ALLOWANCE:	DRAWN BY:
TYPE: SP SOCKET	UNIT: mm	CHECKED BY:
MATERIAL NO :	SCALE:	APPROVED BY:
PROJECTION		东莞市朗纶电子制品有限公司 Dongguan langlun electronic products Co., Ltd